

WHEEL LOADER

# HL940A



The image shows two yellow Hyundai HL940A wheel loaders in a quarry setting. They are positioned on a large pile of grey gravel. The loader in the foreground is facing right, with its bucket lowered. The second loader is further back and to the left, also facing right. The background consists of several large mounds of gravel under a clear sky. The text 'READY TO CHANGE YOUR WORLD' is overlaid in white, bold, sans-serif font in the upper right quadrant of the image.

READY TO CHANGE YOUR WORLD

**The HL940A Wheel Loader is part of Hyundai's A-Series:** a fresh generation of construction equipment that complies with the European stage V emission levels. But it does much more than that! While fulfilling regulatory demands, Hyundai aimed for a ground-breaking level of customer satisfaction with maximum performance and productivity, better safety, more convenience and improved uptime management.

Featuring impressive power matched with carefully selected technologies that help you to work more efficiently and economically, this versatile loader opens up a world of new possibilities. It's time to experience the Hyundai Effect!

# ENTER A WORLD WHERE ANYTHING IS POSSIBLE



## Productivity

- Load sensing hydraulic system
- Accurate weighing control system
- Eco Pedal (option)
- Eco Gauge
- Optimised bucket fill factor
- Variable operating modes

## Durability/Safety

- LED lights (option)
- Sinter brake discs
- Completely sealed engine room
- High grade hoses
- Automatic engine shut-down
- Robust aftertreatment system
- AAVM camera system (option)
- Radar rear detection (option)

## Comfort

- Spacious, soundproofed cabin
- 7" touchscreen monitor
- Ride control system (option)
- Air suspension seat with heater (option)
- Fully adjustable armrest and control lever
- Joystick steering (option)
- Efficient air conditioning

## Serviceability

- Fully openable engine hood
- Extended service intervals
- Centralised access points
- Vertically stacked coolers
- Reversible fan

# TAILORED TECHNOLOGIES TO BOOST YOUR PRODUCTIVITY

The HL940A's reliable Cummins B6.7 Stage V engine delivers all the power you need to tackle heavy-duty work in extreme conditions. Its strong performance at low speed is complemented by a range of technologies that enhance fuel efficiency while keeping harmful emissions to a minimum.

Precise operating systems have been added to ensure you get the most out of the machine's impressive performance. Hyundai's proprietary weighing system technology is integrated as standard. Additional control, monitoring and maintenance features help you to optimise performance and productivity every single day, on any worksite.



The newly developed **parallel z-bar linkage** provides perfect vertical lift function with high tilt forces.

Like all A-Series machines, the HL940A features our **all-in-one exhaust aftertreatment system** which cuts emissions and operating costs while enhancing reliability and simplifying maintenance. High-performing technologies ensure that environmental standards are met without the need for an EGR (Exhaust Gas Recirculation) system. This reduces servicing requirements while maintaining the engine's high working capacity.



**Smart Power mode** reduces fuel consumption by adjusting the engine speed in heavy load work like digging. This function has two key benefits: it not only saves fuel while offering the same performance as Power mode, but also achieves a good balance between traction force and breakout force.

This option ensures that the **engine shuts down automatically when the machine is at rest** to cut fuel consumption and prevent unnecessary emissions.

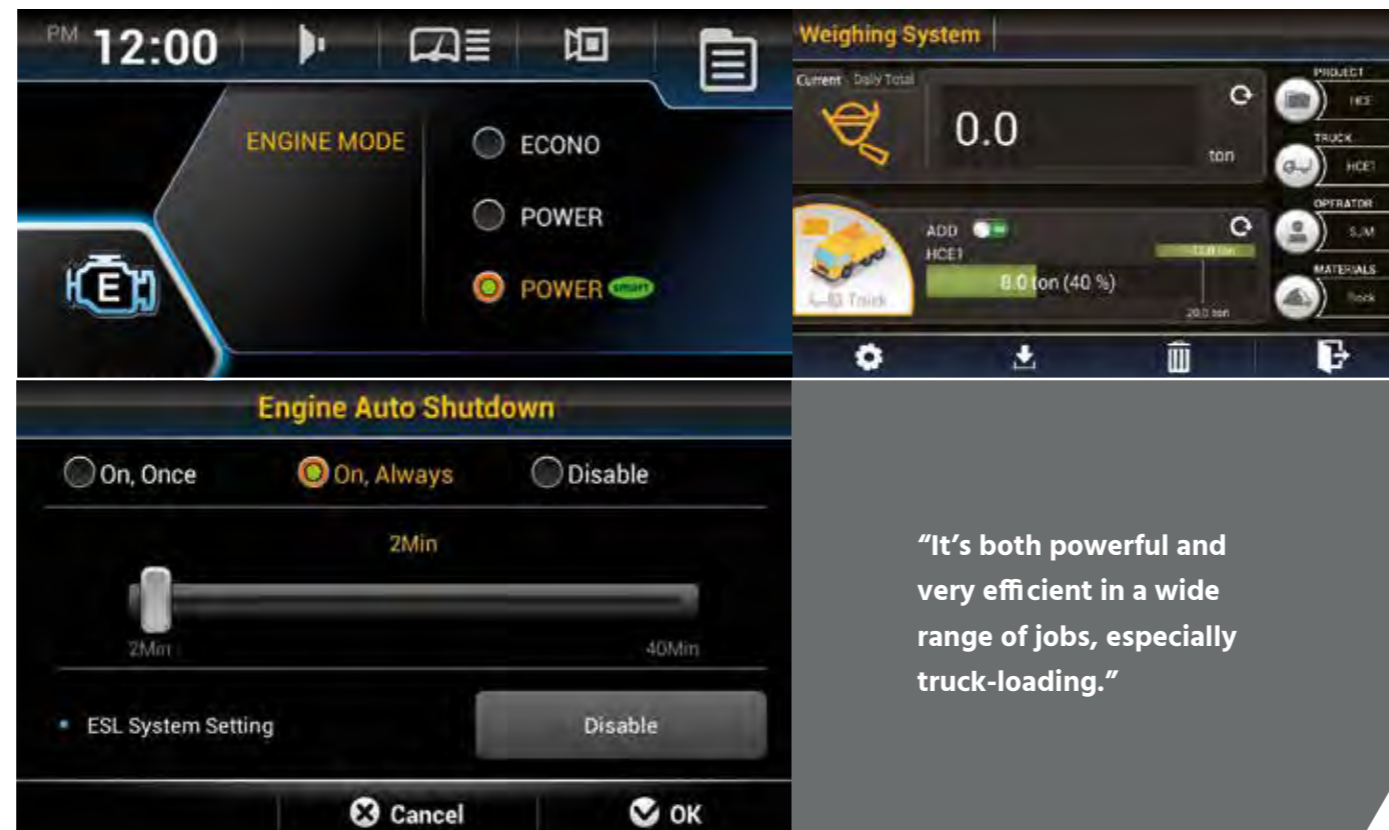

"It's both powerful and very efficient in a wide range of jobs, especially truck-loading."

The highly accurate **automatic/manual cumulative weighing system** helps you to manage production more efficiently in any environment. For maximum precision, weighing error icons and a two-colour weight value indicator are displayed on the monitor.

The **Eco Gauge** shows you engine torque, fuel efficiency and guidance on economical operation while you work.

An **Eco Pedal** allows you to switch the power operating range easily within the optimal fuel consumption range.



# A CABIN DESIGNED AROUND YOU

The HL940A cabin was designed as a productive, stress-free working environment that fits every operator perfectly. Pleasant and spacious, it features state-of-the-art noise and vibration reduction technology, achieving a sound level of only 68 dB, one of the lowest in this machine category. The air conditioning maximises heating and cooling performance by optimising air flow. The seat is large, luxurious and provides comfortable reach to all controls. A range of technologies enable easier machine monitoring, communication and entertainment. The overall design contributes to the confidence and peace of mind that help to create the Hyundai Effect.

“The adjustable seat and the positioning of all the controls make this machine incredibly easy to operate. I don’t get tired, even when I’m working long hours on tough jobs.”



▶ The HL940A has a **large, comfortable seat** with a **headrest** and fully **adjustable armrests**. Cabin space is increased by integrating the attachment control levers in the armrest, which also makes operation more comfortable. An air suspension seat and seat heating are available as options.

▶ The **instrument panel** is optimised to provide quick, easy access to machine status information as you work. It features a seven-inch **touchscreen monitor** for excellent visibility and an audio AUX function for added convenience.

▶ A **ride control system** with piston accumulator is available as an option. This reduces pitching of the wheel loader body and bucket for more stable and comfortable operation, as well as reduced spillage.

▶ The **entertainment system** includes a radio, integrated Bluetooth technology and a built-in microphone for safer, hands-free call handling during your working day.

▶ The **Miracast system based on the operator's smartphone Wi-Fi** allows the use of various smartphone features on the screen, including navigation, web surfing, music and video playback.

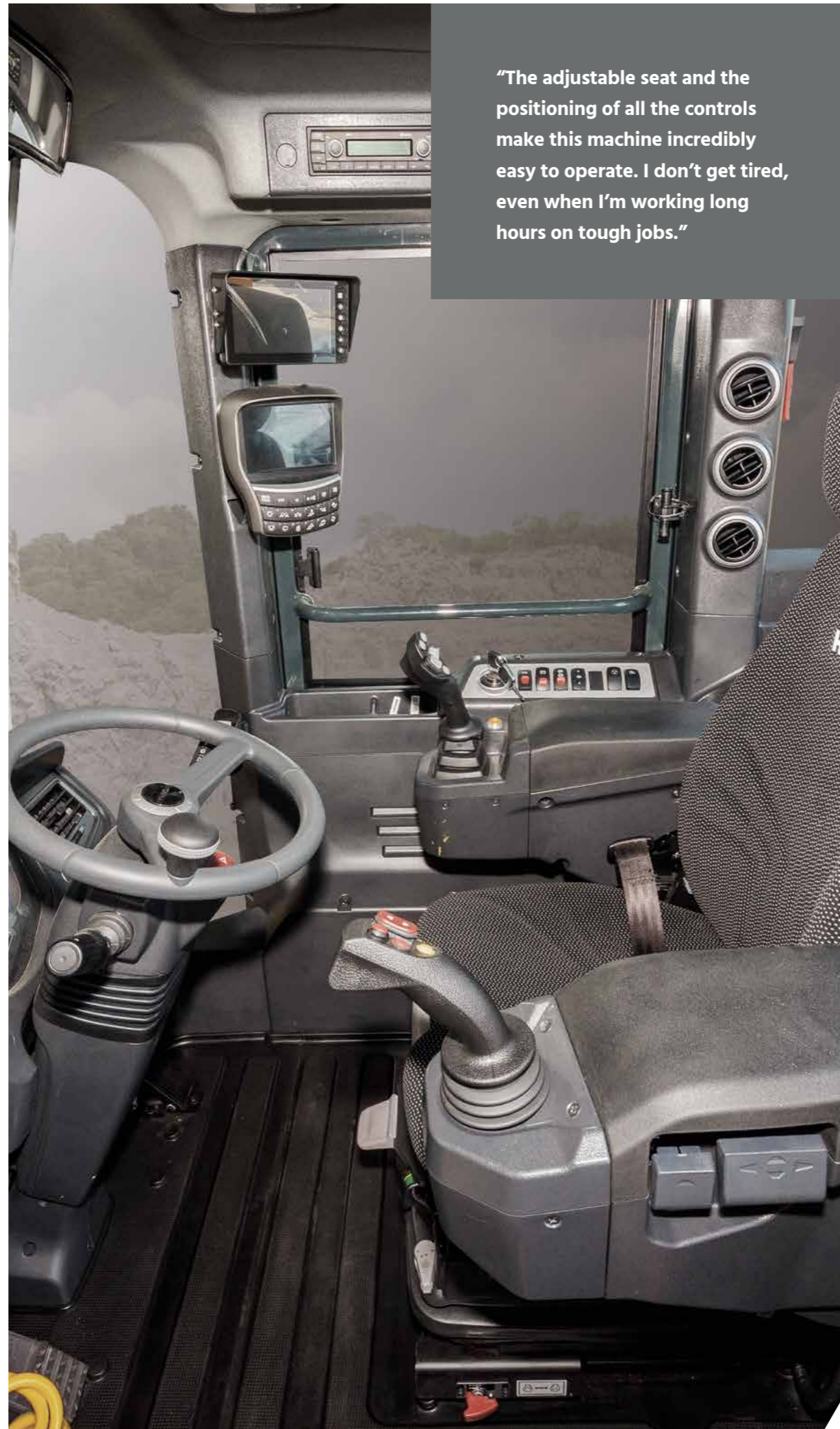

# UPTIME PROTECTION TO SAFEGUARD YOUR PROFITS

To protect your business, you need to know that the investment you make today will sustain your profits over the long term. That's why we prioritised reliability throughout the development of the HL940A, from design and manufacturing to quality control.

The frame and attachments are built for maximum strength, while all operating systems have been optimised for endurance and tested rigorously on a range of work sites. The result is a tough, durable machine that minimises downtime for repairs and maintenance, so you can stay on schedule and protect your profits.



High-grade hoses with outstanding resistance to heat and pressure provide maximum durability, even in demanding conditions.

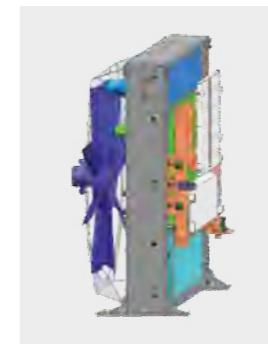

The HL940A has a dependable **wide-core and fin air cooler** that prevents performance degradation caused by contamination. It is also equipped with a **reversible fan** to eliminate dust and debris. A turbo pre-cleaner is available as an option to further extend the replacement cycle.



The **durable aftertreatment system** is protected by a robust support and shock absorbing system. This prevents failure due to shock and vibrations during operation.



Uptime has been increased by extending the standard service interval for the oil and oil filter to 500 hours, which also reduces maintenance costs, and by adding an optional auto-grease system.





## EASY SERVICING FOR TROUBLE-FREE OWNERSHIP

The peace of mind that comes with quick, low-effort servicing is also part of the Hyundai Effect. The HL940A is designed to make maintenance as convenient as possible. The engine hood can be electrically opened completely to provide easy access for cleaning and routine tasks, while the service points for the engine and hydraulic systems are located in one easy-to-reach area. All components and materials have been specially selected to ensure a long, trouble-free life.

When everything's so straightforward and easy to reach, maintenance tasks are a pleasure!"

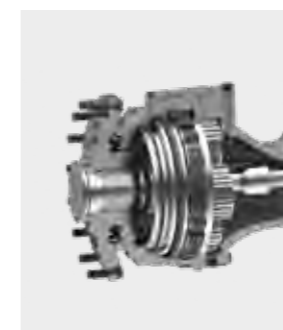

The **brake discs** are manufactured using a durable sinter material to suppress generation of heat and vibration. They extend the lifetime of the brakes, while also integrating a service-friendly design.



The **tilt-back engine hood is fully retractable** and can be **opened electrically** for easy access to the sealed engine room and cooling room. The engine room is designed to prevent the possibility of fire caused by the inflow of foreign materials.

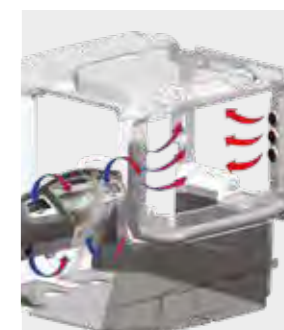

The **air conditioning system** is installed on the right side of the cabin for convenient maintenance and filter replacement. It features a high-capacity inner filter and a specially-selected filter material for superior performance.

# FOCUSED TECHNOLOGIES FOR THE RESULTS YOU WANT

Hyundai's A-Series wheel loaders are designed to create better conditions for operators and deliver the ultimate ownership experience. Every detail is carefully fine-tuned to match your needs in the field, including better safety and comfort, higher productivity, maximum uptime and easy servicing. This is all part of the Hyundai Effect.

See more at [hyundai-ce.eu](http://hyundai-ce.eu)



# SPECIFICATIONS

ENGINE	
Maker / Model	CUMMINS B 6.7 / EU Stage V
Type	Turbocharged, charge air cooled, diesel engine
Aftertreatment System	DOC, DPF, SCR, VGT
Gross Power (SAE J1995)	156 HP (116 kW) at 2,200 rpm
Net Power (SAE J1349)	154 HP (115 kW) at 2,200 rpm
Max. Power	165 HP (123 kW) at 1,800 rpm
Peak Gross Torque (SAE J1995)	746 N·m (550 lb ft) at 1,300 rpm
Displacement	6,700 cc (483 cu in)
- The indicated net power is available for the flywheel when the engine is equipped with a fan, alternator, air cleaner, and after-treatment device. - The indicated gross power is obtained with the fan at maximum speed.	

TRANSMISSION		
Torque converter type*	3-Elements, Single-stage, Single phase	
Tyre	20.5 R25, ★, L3	
Travel speed	4 speed T/M	
Forward	1st	7.0 (4.3)
	2nd	12.8 (7.9)
	3rd	25.2 (15.6)
	4th	40.0 (24.9)
Reverse	1st	7.4 (4.6)
	2nd	13.5 (8.4)
	3rd	26.5 (16.5)

\* Full automatic power shift, countershaft type with soft-shift in range and direction. Properly matched torque converter to engine and transmission for excellent working ability

AXLES	
Drive system	Four-wheel drive system
Mount	Rigid front axle and oscillating rear axle
Rear axle oscillation	Oscillation ±11° of center pin-loaded
Hub reduction	Planetary reduction at wheel end
Differential	Conventional
Reduction ratio	21.53

OVERVIEW		
Description	HL940A	HL940A XT
Operating weight	13,400 kg (29,540 lb)	13,860 kg (30,560 lb)
Bucket capacity	Heaped	2.3 m³ (3.0 yd³)
	Struck	2.0 m³ (2.62 yd³)
Breakout force-bucket	11,800 kg (26,020 lb)	11,940 kg (26,320 lb)
Tipping load	Straight	10,000 kg (22,050 lb)
	Full turn	8,600 kg (18,960 lb)

TYRES	
Type	Tubeless, loader design tyres
Standard	20.5 R25, ★, L3
Options include	20.5-25, 16PR, L3 20.5-25, 20PR, L5 20.5 R25, XHA2

BRAKES	
Service Brakes	Hydraulically actuated, wet disc brakes actuate all 4 wheels independent axle-by-axle system. Self adjusting & wheel speed brake.
Parking Brake	Spring-applied, hydraulically released brake
Emergency Brake	When brake oil pressure drops, indicator light alerts operator and parking brake automatically applies.

HYDRAULIC SYSTEM		
Type	Load sensing hydraulic system	
Pump	Variable displacement piston pump, 149 lpm	
Control valve	2 spool (Bucket, Boom) 3 spool (Bucket, Boom, Aux)	
System pressure	280 bar	
Lift Circuit	The valve has four functions: raise, hold, lower and float. Can adjust automatic kickout from horizontal to full lift.	
Tilt Circuit	The valve has three functions: tilt back, hold and dump. Can adjust automatic bucket positioner to desired load angle.	
Cylinder	Type : double acting	
	No. of cylinders-bore × stroke	
	Lift	2-110 × 738 mm (4.3" × 29")
Cycle Time	HL940A Tilt	125 × 560 mm (4.9" × 1' 10")
	HL940AXT Tilt	125 × 580 mm (4.9" × 1' 11")
Raise: 5.5 sec, Dump: 1.1 sec Lower: 3.0 sec, Total: 9.6 sec		

\* Hyundai Bio Hydraulic Oil (HBHO) available

STEERING SYSTEM		
Type	Load sensing hydrostatic articulated steering	
Pump	Variable displacement piston pump, 149 lpm	
System Pressure	210 bar	
Cylinder	Double acting	2-65 × 429 mm (2.5" × 16.9")
	Steering Angle	40° to both right and left angle, respectively

\* Hyundai Bio Hydraulic Oil (HBHO) available.

SERVICE REFILL CAPACITIES		
UNIT	l	US gal
Fuel tank	220.0	58
DEF tank	30.0	7.9
Cooling system	37.0	9.8
Crankcase	18.0	4.8
Transmission	34.7	9.2
Front axle	23.0	6.1
Rear axle	23.0	6.1
Hydraulic tank	90.0	23.8
Hydraulic system(Including tank)	130.0	34.3

AIR CONDITIONING SYSTEM	
The air condition system for the machine contains the fluorinated greenhouse gas with global warming potential of R134a. (Global Warming Potential : 1430) The system holds 0.75 kg refrigerant consisting of a CO <sub>2</sub> equivalent 1.07 kg metric tonne. For more information, Please refer to the manual.	



# DIMENSIONS

## DIMENSIONS

All dimensions are approximate.

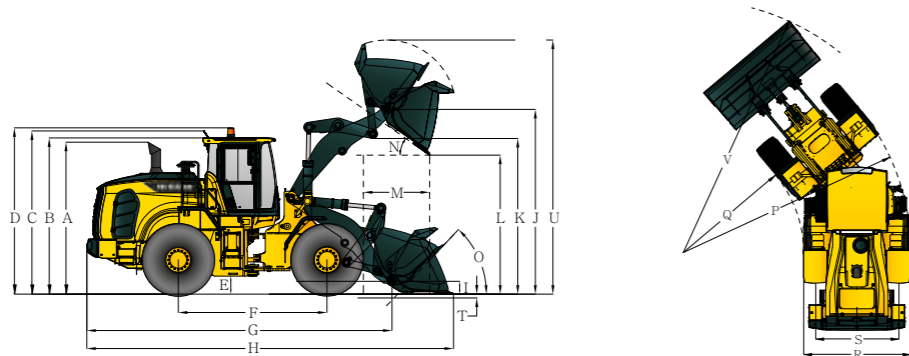

Description	HL940A		HL940AXT	
	mm	ft in	mm	ft in
A Height to Top of Exhaust Pipe	3,310	10' 10"	3,310	10' 10"
B Height to Top of Cabin	3,300	10' 10"	3,300	10' 10"
C Height to Top of Product Link Antenna	3,445	11' 4"	3,445	11' 4"
D Height to Top of Warning Beacon	3,430	11' 3"	3,430	11' 3"
E Ground Clearance	432	1' 5"	432	1' 5"
F Wheelbase	3,000	9' 10"	3,000	9' 10"
G Overall Length (Without Bucket)	6,430	21' 1"	7,020	23'
H Shipping Length (With Bucket Level on Ground)	7,600	24' 11"	8,190	26' 10"
I Hinge Pin Height at Carry Position	430	1' 5"	600	2'
J Hinge Pin Height at Maximum Lift	3,820	12' 6"	4,425	14' 6"
K Lift Arm Clearance at Maximum Lift	3,235	10' 7"	3,840	12' 7"
L Dump Clearance at Maximum Lift and 45° Discharge	2,765	9' 1"	3,370	11.1'
M Reach at Maximum Lift and 45° Discharge	1,095	3' 7"	1,090	3' 7"
N Dump Angle at Maximum Lift and Dump (on Stops)	48		47	
O Roll Back Angle	Ground		42	
	Carry		50	
P Clearance Circle (Diameter) to Outside of Tyres	10,910	35' 10"	10,910	35' 10"
Q Clearance Circle (Diameter) to Inside of Tires	5,910	19' 5"	5,910	19' 5"
R Width Over Tyres (Unloaded)	2,450	8'	2,450	8'
S Tread Width	1,930	6' 4"	1,930	6' 4"

## OPERATING SPECIFICATIONS WITH BUCKETS

Linkage Bucket Type	General Purpose Pin On		General Purpose Hook On	High Lift Linkage Change
	Bolt-On Cutting Edges	Bolt-On Cutting Edges	Bolt-On Cutting Edges	
Edge Type	Bolt-On Cutting Edges	Bolt-On Cutting Edges	Bolt-On Cutting Edges	
Capacity - Rated	2.3 m³ (3.0 yd³)	2.1 m³ (2.7 yd³)	2.3 m³ (3.0 yd³)	-
Capacity - Rated at 110% Fill Factor	2.5 m³ (3.3 yd³)	2.3 m³ (3.0 yd³)	2.5 m³ (3.3 yd³)	-
Width	2,600 mm (8' 6" ft/in)	2,550 mm (8' 4" ft/in)	2,600 mm (8' 6" ft/in)	-
Dump Clearance at Maximum Lift & 45° Discharge	2,765 mm (9' 1" ft/in)	2,795 mm (9' 2" ft/in)	2,640 mm (8' 8" ft/in)	+605 mm (+1' 12" ft/in)
Reach at Maximum Lift & 45° Discharge	1,095 mm (3' 7" ft/in)	1,065 mm (3' 6" ft/in)	1,220 mm (4' ft/in)	-5 mm (-0.2" ft/in)
Digging Depth	90 mm (3.5" ft/in)	90 mm (3.5" ft/in)	90 mm (3.5" ft/in)	+40 mm (+1.6" ft/in)
Shipping Length (with Bucket)	7,600 mm (24' 11" ft/in)	7,560 mm (24' 10" ft/in)	7,775 mm (25' 6" ft/in)	+590 mm (+1' 11" ft/in)
Overall Height with Bucket at Maximum Lift	5,185 mm (17" ft/in)	5,145 mm (16' 11" ft/in)	5,395 mm (17' 8" ft/in)	+605 mm (+1' 12" ft/in)
Loader Clearance Circle with Bucket at Carry Position	12,180 mm (40' ft/in)	12,110 mm (39' 9" ft/in)	12,280 mm (40' 3" ft/in)	+570 mm (+1' 10" ft/in)
Static Tipping Load. Straight (No Tire Deflection)	10,000 kg (22,050 lb)	10,100 kg (22,270 lb)	9,200 kg (20,280 lb)	-1,850 kg (-4,079 lb)
Static Tipping Load. Articulated (No Tire Deflection)	8,600 kg (18,960 lb)	8,700 kg (19,180 lb)	7,900 kg (17,420 lb)	-1,550 kg (-3,417 lb)
Breakout Force	11,800 kg (26,020 lb)	12,230 kg (26,960 lb)	10,200 kg (22,490 lb)	+140 kg (+309 lb)
Operating Weight*	13,400 kg (29,540 lb)	13,360 kg (29,450 lb)	13,675 kg (30,150 lb)	+460 kg (+1,014 lb)

\* All height and tyre related dimensions are with standard 23.5 R25, L3 tyres.

# DENSITY AND BUCKET SELECTION

## DENSITY OF OPERATING MATERIALS

Loose Material	Material Density [ton / m³]	
Earth / Clay	1.5 ~ 1.7	
Sand and Gravel	1.5 ~ 1.7	
Aggregate	25 ~ 76 mm (1 to 3 in)	1.6 ~ 1.7
	19 mm (0.75 in) and larger	1.8

## HL940A BUCKET SELECTION CHART

### Standard Lift Arm - General Purpose Bucket

Type	m³ (yd³)	Material Density [ton / m³]												
		1.1	1.2	1.3	1.4	1.5	1.6	1.7	1.8	1.9	2.0	2.1	2.2	2.3
Cutting edge	2.3 (3.0)	2.6 m³ (3.4 yd³)						2.2 m³ (2.9 yd³)						
Cutting edge	2.1 (2.7)	2.4 m³ (3.1 yd³)						2.0 m³ (2.6 yd³)						
Cutting Edge Q/C	2.3 (3.0)	2.6 m³ (3.4 yd³)						2.2 m³ (2.9 yd³)						

### High lift arm (XT) - General Purpose

Type	m³ (yd³)	Material Density [ton / m³]												
		1.1	1.2	1.3	1.4	1.5	1.6	1.7	1.8	1.9	2.0	2.1	2.2	2.3
Cutting edge	2.3 (3.0)	2.6 m³ (3.4 yd³)		2.2 m³ (2.9 yd³)										
Cutting edge	2.1 (2.7)	2.4 m³ (3.1 yd³)						2.0 m³ (2.6 yd³)						
Cutting Edge Q/C	2.3 (3.0)	2.6 m³ (3.4 yd³)		2.2 m³ (2.9 yd³)										



## CHANGE IN OPERATING SPECIFICATIONS - TYRES

Tyres		20.5-25 16PR L5(LT05)	20.5 R25 XHA(LT25)	20.5-25 16PR L3(LT53)
Operating Weight (kg)	kg	+440	-52	-108
	lb	+970	-115	-238
Static Tipping Load. Straight (No Tyre Deflection)	kg	+300 (+245)	-35 (-30)	-75 (-60)
	lb	+661 (+540)	-77 (-66)	-165 (-132)
Static Tipping Load. Articulated (No Tyre Deflection)	kg	+260 (+210)	-30 (-25)	-65 (-50)
	lb	+573 (+463)	-66 (-55)	-143 (-110)
Vertical Height Changes	mm	+65	-7	-3
	ft/in	+3"	-0.3"	-0.1"
R. Width Over Tyres (Unloaded)	mm	+27	-6	-6
	ft/in	+1.1"	-0.2"	-0.2"
P. Clearance Circle (Diameter) to Outside of Tyres	mm	+27	-6	-6
	ft/in	+1"	-0.2"	-0.2"
Q. Clearance Circle (Diameter) to Inside of Tyres	mm	-27	+6	+6
	ft/in	-1"	+0.2"	+0.2"

\* Dimension Changes Compared to 20.5R25, ★, L3 tyres.



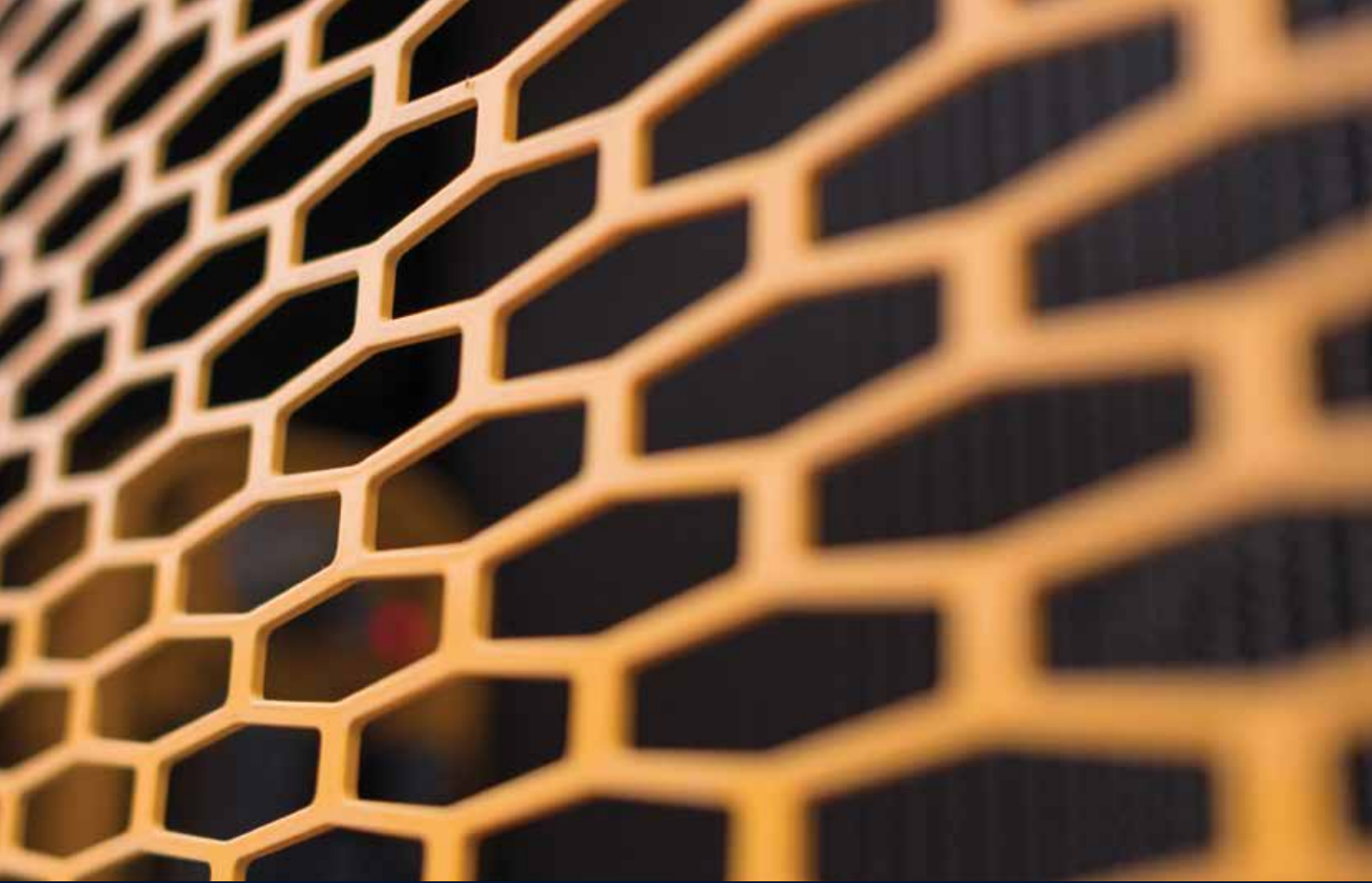

Specifications and design are subject to change without notice. Pictures of Hyundai Construction Equipment Europe products may show other than standard equipment.

Hyundai Construction Equipment Europe nv.  
Hyundailaan 4, 3980 Tessenderlo, Belgium.  
Tel: (32) 14-56-2200 Fax: (32) 14-59-3405

EN - 2020.03 Rev 1

**Ready to experience the Hyundai Effect?**

**Contact your Hyundai dealer.**

**[hyundai-ce.eu/en/dealer-locator](https://hyundai-ce.eu/en/dealer-locator)**

