

# HX140AL

CRAWLER EXCAVATOR



**SERIES / HX140AL**

**Gross Power**  
100 kW (134 HP) at 2200 rpm

**Bucket Capacity**  
0.50 ~ 0.77 m<sup>3</sup>

**Net Power**  
98 kW (131 HP) at 2200 rpm

**Operating Weight**  
14405 kg

# READY TO CHANGE YOUR WORLD

Our new A-Series HX140A L crawler excavator is ready to build your world. Its high performance engine delivers better productivity and fuel efficiency while meeting EU Stage V emissions regulations. Featuring a new tough exterior design with added safety features and greater serviceability, you can rely on the HX140A L to perform in the toughest conditions on large construction sites and infrastructure projects.



# THE BEST PRODUCTIVITY AND FUEL EFFICIENCY

From its upgraded, eco-friendly engine to its carefully chosen control technologies, the HX140A L excavator helps operators to achieve new heights of productivity. Hyundai's EPIC (Electric Pump Independent Control) hydraulic system, in connection with automatic engine shutdown, eco gauge and lifting mode, allows the machine to deliver the exact performance and efficiency when and where it's needed.

## EU Stage V Certified Engine

Featuring an EGR-free design that delivers 3% more power and 12% more peak torque, that when combined with increased fuel economy and longer maintenance intervals contribute to a reduced cost of operation.

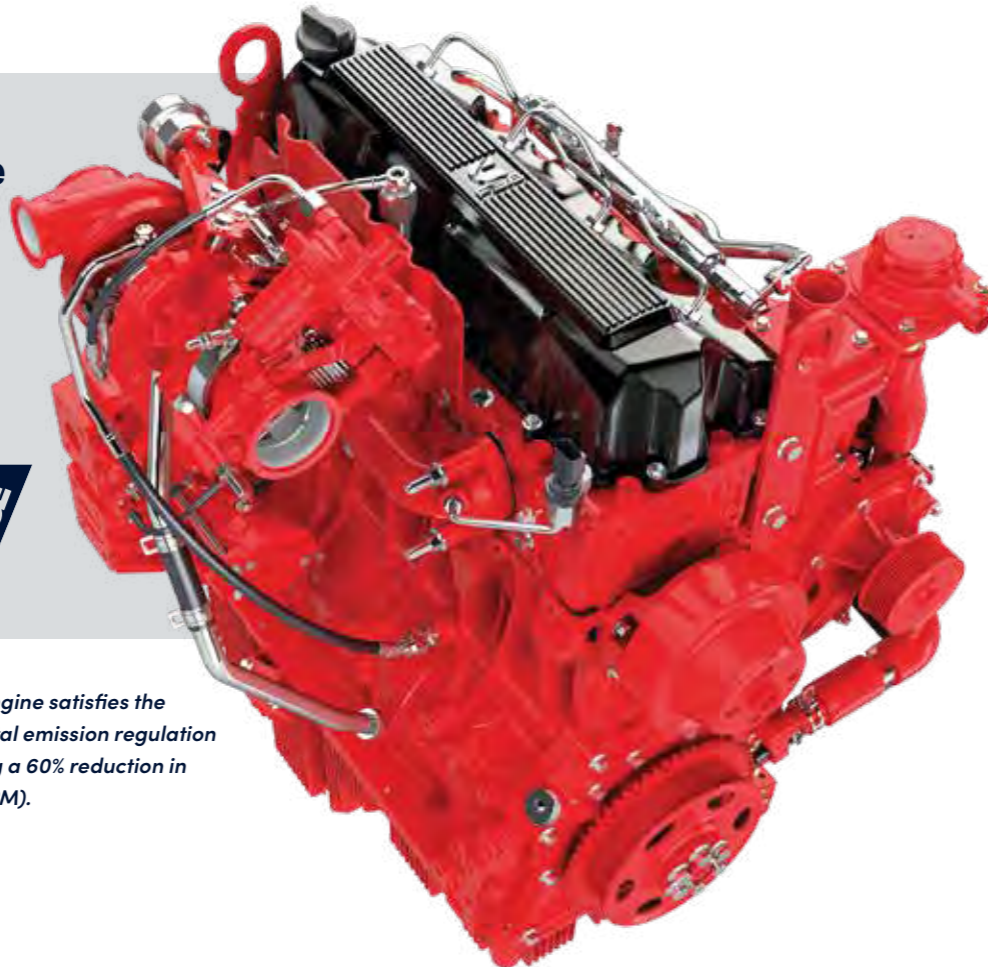

*The Cummins F3.8 engine satisfies the strictest environmental emission regulation in the world including a 60% reduction in Particulate Matter (PM).*

## The technology to improve efficiency

### EPIC

The HX A-Series adopts the upgraded EPIC system. It is able to optimise pump flow rate and power at various working conditions through the individual pump control. Furthermore, the optimised design of MCV and pipe line minimises energy loss such as conflux and throttle loss.

### Lifting mode

This work mode improves fine control and lift capability through RPM reduction, power boost activation and pump flow control.

### Automatic Engine Shutdown

Adjustable 'Automatic Engine Shutdown' significantly reduces idle time, overall operating hours and fuel consumption.



Intelligent Power Control

*Increased fuel economy and longer maintenance intervals contribute to a reduced cost of operation.*



UP TO  
**11%**  
EFFICIENCY  
(Compared to previous model)

## All the information to improve economy

### Eco report

It reports on any inefficient operation status and helps improve an operator's working habit

### Fuel rate information

Fuel information is displayed as average rate and latest fuel consumed, for guidance to economical operating.

### Eco gauge

Helps operators to reduce emissions and running costs by constantly monitoring efficiency. It displays engine workload and fuel-saving status while the machine is working.



Eco Gauge

# NEW EXTERIOR DESIGN FOR ROBUSTNESS AND SAFETY

The true value of the HX A-Series lies in its durability and high productivity. The robust upper and lower frame structure can endure external shock and heavy work loads. Attachment performance has been proven through rigorous field testing. No matter how tough the working environment is, you can always rely on the HYUNDAI Excavator HX A-Series.

## Tougher from the ground up

### Reinforced durability ▶

The upper and lower structure and attachments of HX A-Series machines have higher durability than demanded on site, as proven through numerous tests including on the road and virtual simulation. The wear resistance of the bucket has also been improved by using a new, harder material.

### Hi-grade (high-pressure) hoses **A**

The HX A-Series uses high-pressure hoses with improved heat and pressure resistance, greatly increasing the durability of the equipment.

### Side protector **B**

This protects the frame sides during operation in narrow areas.

*The robust upper and lower frame structure can endure external shock and heavy work loads.*

*Dozer option adds extra versatility.*

### Durable cooling module ▶

The HX A-Series has a durable cooling module that has passed stringent tests, demonstrating the highest productivity in tough working environments.



### Cabin structure

The HX A-Series cabin structure uses integrally welded low-stress, high strength steel to meet ROPS and FOG certification.

- **ROPS:** Roll-Over Protective Structures ISO12117-2
- **FOG:** Falling Object Guard, ISO10262 Level2

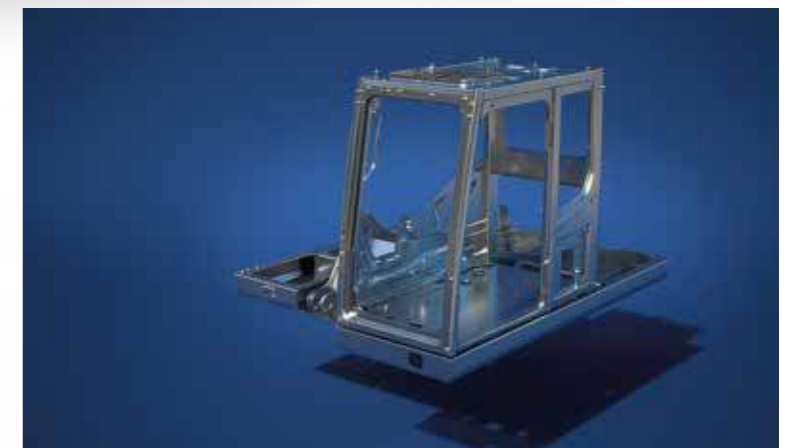

# EASY CONTROL AND COMFORTABLE OPERATION

Many electronic functions are concentrated in the most convenient spot for operators to improve work efficiency. The highly-advanced infotainment system, a product of Hyundai's intensive information technology development, enables both productivity and comfort while working! The HX A-Series really is designed with the operator in mind.

## Ergonomic for efficient operation

### Intelligent & wide cluster ▶

The 8" capacitive-type display is similar to a smartphone to deliver excellent legibility. The centralised switches on the display allow convenient checking of the Adblue/DEF level and temperature outside the cabin.



### One pedal to travel straight ▶

One pedal for straight travel is available for customers' convenience when long distance travelling or a combination of attachment work with travelling is necessary.



### Proportional auxiliary hydraulic system ▶

A proportional control switch with better speed control provides operators with added convenience whenever they do time-consuming work. This function can also be switched to control by foot pedal, by changing the setting in the cluster menu.



### Jog Dial Module ▶

The accelerator, remote air conditioner controller and instrument cluster can be operated using the convenient jog shuttle-type controller.



## Functionality at your fingertips

### Boom/Arm speed

Boom-up speed compared to swing speed can be adjusted by activating/deactivating the boom priority function. Arm-in speed can be also tuned by activating/deactivating the arm regeneration function.

### Work mode memory

The operator can save machine settings, so that they are applied when starting the machine.

### OME (Owner Menu Editing)

The machine owner can restrict operator access to the set of functions via the menu as well as locking or unlocking it. A password is then needed to access the functions.

### Fine (cushion/free) swing control

This option enables smooth movement at the start and stop of swing operation (cushion swing). In addition, it reduces the shaking of the weight when lifting operation (free swing).

The HX A-Series is designed with the operator in mind. Many electronic functions are concentrated in the most convenient spot for operators to improve work efficiency.



Pilot pressure operated joysticks and pedals with detachable lever provide almost effortless operation.

**13%**  
INCREASE IN CABIN SPACE

# THE ULTIMATE SAFE ENVIRONMENT

The Hyundai approach to safety goes far beyond just meeting regulatory standards. We prioritise safety in every aspect of our machines and work with our customers to keep improving protection for operators, co-workers, passers-by, surrounding buildings and of course the machines themselves.

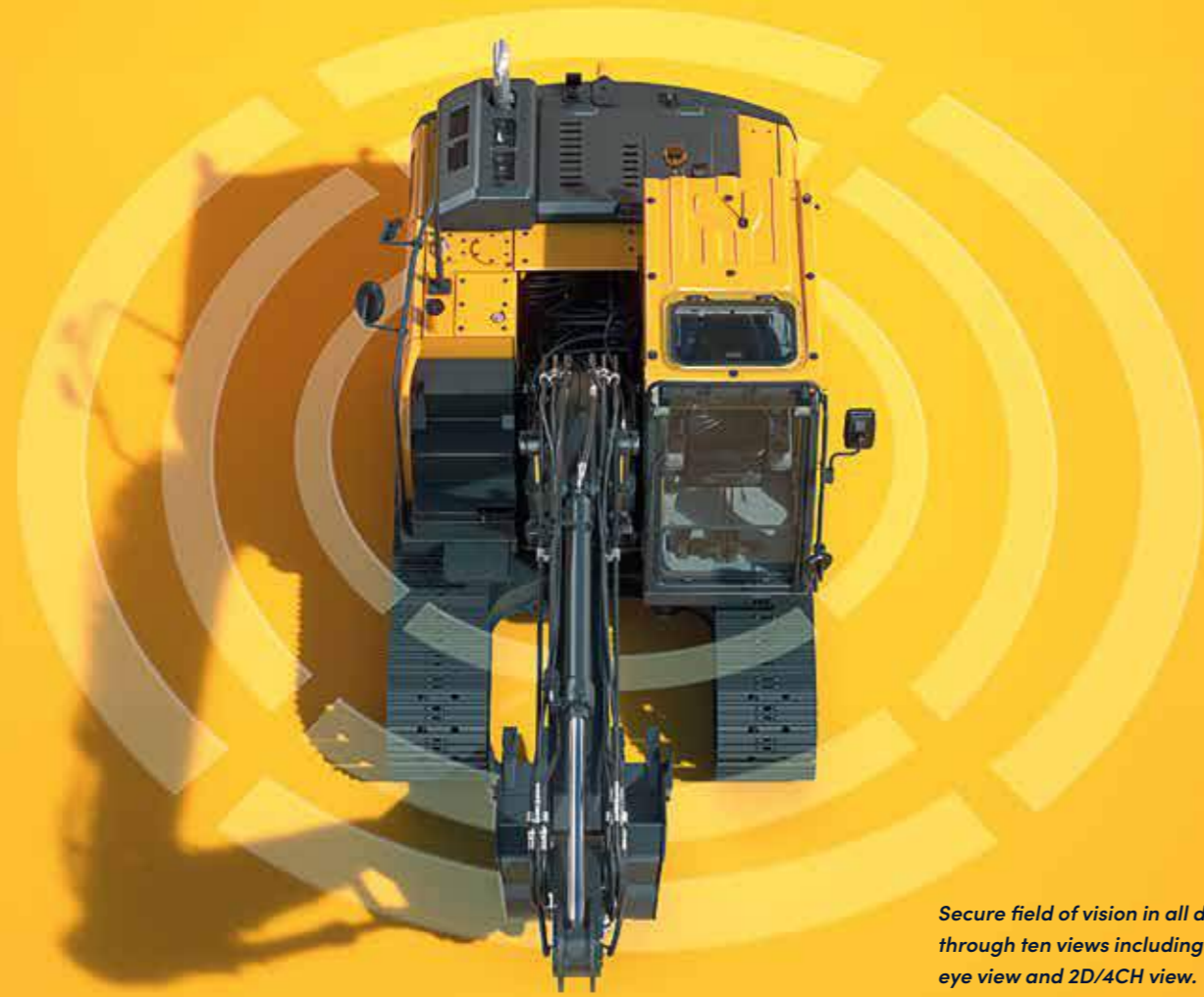

Secure field of vision in all directions through ten views including 3D bird's eye view and 2D/4CH view.

## Visibly safer

### AAVM (Advanced Around View Monitoring) camera system

The HX A-Series has a state-of-the-art AAVM video camera system to give an unobscured 360 degree field of vision for operators.

- **IMOD (Intelligent Moving Object Detection):** Informs when people or dangerous objects are detected within the range of operation (recognition distance: 5m).



## Built for safer operation

### Cabin viscous mount

A coil spring and damper inside the cabin viscous mounts improve durability and provide a comfortable operating environment that lessens fatigue.

### Emergency engine stop switch

A manual engine stop switch located behind the seat can be used in emergencies. It can also be reached from outside the cabin.

### Electronic swing brake

An electronic valve and control system has been added to improve safety and utilisation. The opening and closing time of the swing brake valve is controlled according to the sensing and control system.

### Seat belt warning alarm

If the seatbelt is not buckled when the ignition key is turned, an alarm is triggered in intervals along with a continuous visual alert. This emphasises our priority for operator safety.

### Side camera

In addition to the standard rear view camera, there is an optional right hand side camera for giving the operator improved visibility.



### Visibility and handle improvement ▲

Visibility through the cabin door has been improved as has the handle design, to offer greater convenience when getting in and out of the cabin.



### Activate Auto Safety Lock

The Auto Safety Lock prevents unintended operation due to the excavator not being controlled solely by the RCV lever.

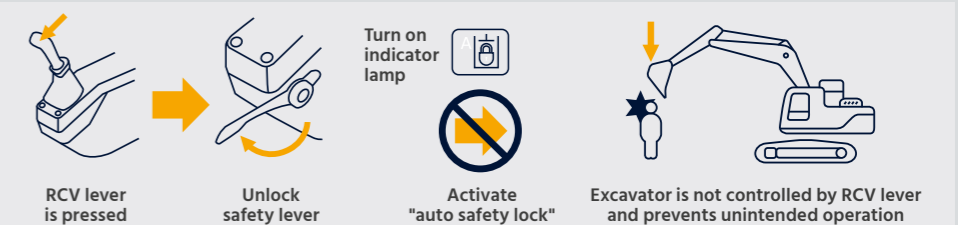

# SERVICEABILITY AND TELEMATICS

Our A-Series excavators are designed with quick, low-effort servicing in mind. Every component and material has been optimised to ensure a long, trouble-free life. Hyundai's innovative Hi MATE telematics system enables full monitoring of machine activity and performance. Maximum connectivity is integrated to help owners create a smart construction site and protect profitability as their business grows.

## Less maintenance. More uptime

### Improved routine maintenance

Easy access for maintenance means regular checks get done faster, giving you more uptime and reducing operating costs. Ground level access to filters, lube fittings and master switches make servicing more convenient.

### 2 x longer lasting filter (1000 hr)

Service intervals have increased by 100% from 500hrs to 1000hrs when using CK-4 engine oil on the following items, engine oil, pre-filter, engine oil filter and fuel filter.

**100%**  
IMPROVEMENT IN SERVICE INTERVAL



## Hi MATE

It's convenient, easy and valuable. Hi MATE, Hyundai's remote management system, utilises GPS-satellite technology to provide customers with the highest level of service and product support available.

### Increase productivity

By providing information such as service hours, idle time and fuel consumption, Hi MATE saves you money and improves productivity. Service alerts enable better maintenance planning.

### ECD

#### (Engine Connected Diagnostics)

ECD provides troubleshooting information as well as tailored servicing. Service technicians are supported with remote diagnostics allowing them to achieve quick resolution rate

### Monitor your machines

Hi MATE's real-time location information allows convenient monitoring of your equipment via the Hi MATE website or mobile app.

### Mobile fleet app

Our Mobile Fleet app provides all the information you need to run your fleet efficiently and economically.

### Improve Security

Protect your equipment from theft or unauthorised usage. Hi MATE's geofencing alerts notify you automatically when a machine leaves a predetermined zone.

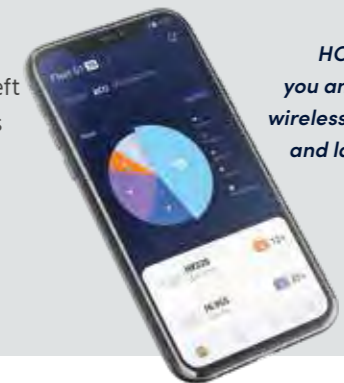

*HCE-DT Air connects you and your equipment wirelessly via smartphone and laptop right on site.*

## Keeping you covered

Hyundai genuine parts and accessories are designed to keep your machine running at optimum performance, providing increased uptime, comfort and productivity. Our 13000m<sup>2</sup> European Parts Warehouse guarantees 24-hour delivery across our dealer network.

Hyundai Standard and Extended Warranty Programmes are also available, providing peace of mind and giving you full control over your operating costs.



# TAKE THE TOUR!

## Productivity & Efficiency

- EU STAGE V Engine
- Eco Report
- Lifting Mode
- EPIC
- Fuel Rate Information
- Eco Gauge
- Automatic Engine Shutdown

## Ease of Use

- Work mode memory
- Visibility and handle improvement
- One pedal straight travel
- Proportional auxiliary hydraulic system
- 2 way proportional RCV & pedal control selection
- Fine (cushion/free) swing control
- Intelligent & wide cluster
- Jog dial module
- OME (Owner Menu Editing)
- Boom / arm speed adjustment

## Durability

- Frame side protection
- ROPS & FOG cabin
- Reinforced durability
- Durable cooling module
- High-grade hoses

## Serviceability & Connectivity

- Hi MATE
  - ECD (Engine Connected Diagnostics)
  - Mobile fleet app
- HCE-DT Air
- Longer lasting filter
- Improved routine maintenance

## Safety

- Auto safety lock
- Electronic swing brake
- AAVM camera system
- Side view camera
- Seatbelt warning alarm
- Emergency engine stop switch





# SPECIFICATIONS

SPECIFICATIONS		HX140A L	
<b>ENGINE</b>			
Maker / Model	Cummins F3.8		
Type	4-cycle, turbocharged, charge air cooled, electronic		
Gross Power (SAE J1995)	100 kW (134 hp) at 2200 rpm		
Net Power (SAE J1349)	98 kW (131 hp) at 2200 rpm		
Max. Power	100 kW (134 hp) at 2200 rpm		
Peak Torque	550 Nm at 1500 rpm		
Displacement	3.8 l		
<b>HYDRAULIC SYSTEM</b>			
<b>MAIN PUMP</b>			
Type	Variable displacement tandem axis piston pumps		
Max. flow	2 × 123.5 l/min		
<b>PILOT PUMP</b>			
Type	Fixed displacement gear pump single stage		
Max. flow	28.5 l/min		
<b>HYDRAULIC MOTORS</b>			
Travel	Variable displacement axial piston motor		
Swing	Two fixed displacement axial piston motor		
<b>RELIEF VALVE SETTING</b>			
Auxiliary Circuits	350 kgf/cm <sup>2</sup>		
Travel	350 kgf/cm <sup>2</sup>		
Power Boost (Boom, Arm, Bucket)	380 kgf/cm <sup>2</sup>		
Swing Circuit	280 kgf/cm <sup>2</sup>		
Pilot Circuit	40 kgf/cm <sup>2</sup>		
Service Valve	Installed		
<b>HYDRAULIC CYLINDERS</b>			
No. of Cylinder Bore X Stroke	Boom: Ø105 × 1075 mm		
	Arm: Ø115 × 1138 mm		
	Bucket: Ø100 × 850 mm		
	Blade: 2-Ø100 × 250 mm		
2PCS	1st: 2-Ø105 × 975 mm		
	2nd: 1-Ø145 × 613 mm		
* Hyundai Bio Hydraulic Oil (HBHO) available			
<b>DRIVES &amp; BRAKES</b>			
Drive Method	Fully hydrostatic type		
Drive Motor	Axial piston motor, in-shoe design		
Reduction System	Planetary reduction gear		
Max. Drawbar Pull	HX140A L	HX140AHW	
	12670 kgf	16660 kgf	
Max. Travel Speed (High / Low)	3.2 km/hr / 5.5 km/hr	2.4 km/hr / 4.3 km/hr	
	Gradeability 35° (70%)		
Parking Brake	Multi wet disc		
<b>CONTROLS</b>			
Pilot pressure operated joysticks and pedals with detachable lever provide almost effortless and fatigueless operation.			
Pilot Control	Two joysticks with one safety lever (LH): Swing and arm		
	(RH): Boom and bucket		
Traveling and Steering	Two levers with pedals		
Engine Throttle	Electric, Dial type		
<b>SWING SYSTEM</b>			
Swing Motor	Fixed displacement axial piston motor		
Swing Reduction	Planetary reduction gear		
Swing Bearing Lubrication	Grease-bathed		
Swing Brake	Multi wet disc		
Swing Speed	11.4 rpm		

SPECIFICATIONS		HX140A L			
<b>SERVICE CAPACITIES</b>					
	liter				
Fuel Tank	270				
Engine Coolant	21				
Engine Oil	12				
Swing Device	3.5				
Final Drive (Each)	2.3				
Hydraulic System (Including Tank)	210				
Hydraulic Tank	120				
Def/Adblue®	35				
<b>UNDERCARRIAGE</b>					
The X-leg type center frame is integrally welded with reinforced box-section track frames. The undercarriage includes lubricated rollers, idlers, track adjusters with shock absorbing springs and sprockets, and a track chain with double or triple grouser shoes.					
Center Frame	X - Leg Type				
Track Frame	Pentagonal Box Type				
	HX140A L(D)	HX140AHW			
		700/800 mm	900 mm		
		Triple grouser	Triple grouser		
No. of Shoes on Each Side	46	47	47		
No. of Carrier Roller	2 x 1	2 x 2	2 x 2		
No. of Track Roller	2 x 7	2 x 7	2 x 7		
No. of Rail Guard	2 x 1	Full Rail Guard	2 x 2		
<b>OPERATING WEIGHT</b>					
Operating weight, including 4600 mm boom, 2500 mm arm, SAE heaped 0.58 m <sup>3</sup> bucket, lubricant, coolant, full fuel tank, full hydraulic tank, and all standard equipments.					
<b>OPERATING WEIGHT</b>					
Shoes	Operating Weight		Ground Pressure		
Type	Width (mm)	kg	kgf / cm <sup>2</sup>		
Triple Grouser	500	HX140A L	14200	0.44	
		HX140A L Dozer	15015	0.46	
	600	HX140A L	14405	0.37	
		HX140A L Dozer	15230	0.39	
	700	HX140A L	14625	0.32	
		HX140A L Dozer	15460	0.34	
	800	HX140AHW		17225	0.37
		HX140AHW		17460	0.33
	900	HX140AHW (Mud)		17180	0.29
	<b>NOISE</b>				
Operator Sound Pressure Level (ISO 6396:2008)		71 dB(A)			
Exterior Sound Power Level (ISO 6395:2008)		99 dB(A)			
<b>AIR CONDITIONING SYSTEM</b>					
The air conditioning system contains fluorinated greenhouse gas refrigerant R134a (Global Warming Potential = 1430). The system contains 0.75 kg of refrigerant representing a CO <sub>2</sub> equivalent of 1.07 metric tonnes.					

# DIMENSIONS & WORKING RANGE

## HX140A L MONO BOOM DIMENSIONS

4.60 m, 4.1 m BOOM and 1.90 m, 2.10 m, 2.50 m, 3.00 m ARM

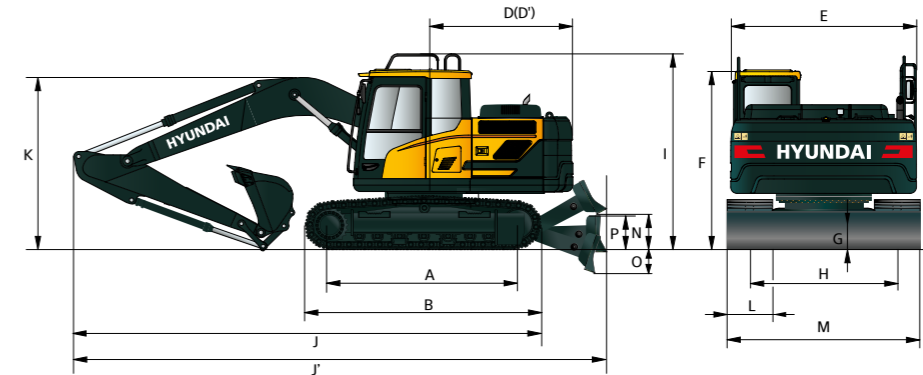

Unit : mm

A	Tumbler Distance	3000
B	Overall Length of Crawler	3696
C	Ground Clearance of Counter Weight	930
D	Tail Swing Radius	2345
D'	Rear-End Length	2335
E	Overall Width of Upper Structure	2475
*F	Overall Height of Cab	2860
*G	Min. Ground Clearance	430
H	Track gauge	1990
*I	Overall Height of Guardrail	3110

	Boom length	4600				4100	
		1900	2100	2500	3000	1900	2100
J	Overall Length	7830	7855	7830	7795	7320	7355
J'	Overall Length (W/Dozer)	8165	8190	8165	9130	7655	7690
K	Overall Height of Boom	2675	2820	2800	3130	2740	2895

L	Track Shoe	500	600	700
M	Overall Width	2490	2590	2690

**N	Ground clearance of blade up	580
**O	Depth of blade down	475
**P	Height of blade	575

\* This figure includes the size of grousers.

\*\* With dozer blade option.

## HX140A L MONO BOOM WORKING RANGE

Unit : mm

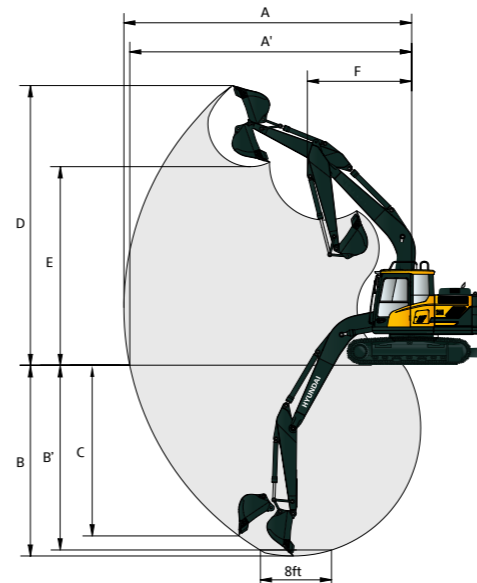

	Boom Length	4600				4100	
		1900	2100	2500	3000	1900	2100
A	Max. Digging Reach	7750	7920	8320	8780	7250	7420
A'	Max. Digging Reach on Ground	7590	7760	8170	8640	7080	7250
B	Max. Digging Depth	4915	5115	5515	6015	4500	4700
B'	Max. Digging Depth (8' Level)	4650	4860	5300	5830	4240	4450
C	Max. Vertical Wall Digging Depth*	4470	4660	5065	5570	4060	4250
D	Max. Digging Height	8130	8200	8530	8800	7730	7790
E	Max. Dumping Height	5690	5770	6080	6350	5285	5360
F	Min. Swing Radius	2620	2670	2650	2670	2350	2460

\* This dimension varies with kinds of buckets.

# DIMENSIONS & WORKING RANGE

## HX140A L 2-PIECE BOOM DIMENSIONS

4.90 m BOOM and 1.90 m, 2.10 m, 2.50 m ARM

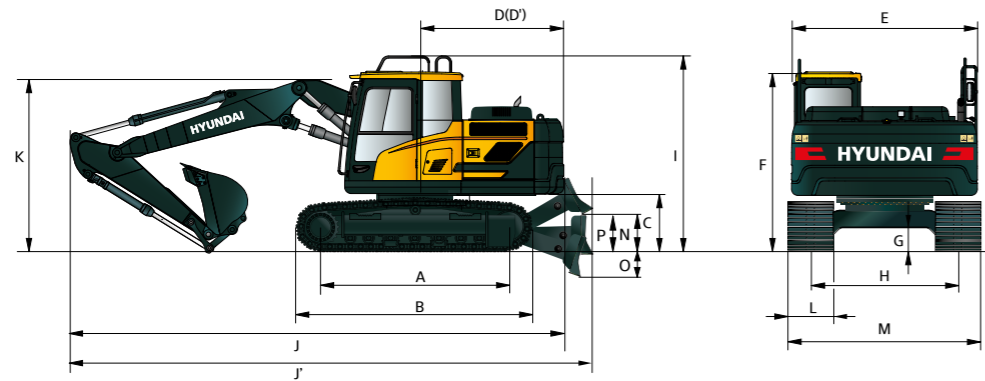

Unit : mm

A	Tumbler Distance	3000
B	Overall Length of Crawler	3696
*C	Ground Clearance of Counter Weight	930
D	Tail Swing Radius	2345
D'	Rear-End Length	2335
E	Overall Width of Upper Structure	2475
*F	Overall Height of Cab	2860
*G	Min. Ground Clearance	430
H	Track gauge	1990
*I	Overall Height of Guardrail	3110

Boom length		4900		
Arm length		1900	2100	2500
J	Overall Length	8170	8180	8155
J'	Overall Length (W/Dozer)	8505	8515	8490
K	Overall Height of Boom	2805	2900	2925

L	Track Shoe	500	600	700
M	Overall Width	2490	2590	2690

**N	Ground clearance of blade up	580
**O	Depth of blade down	475
**P	Height of blade	575

\* This figure includes the size of grouser.

\*\* With dozer blade option.

## HX140A L 2-PIECE BOOM WORKING RANGE

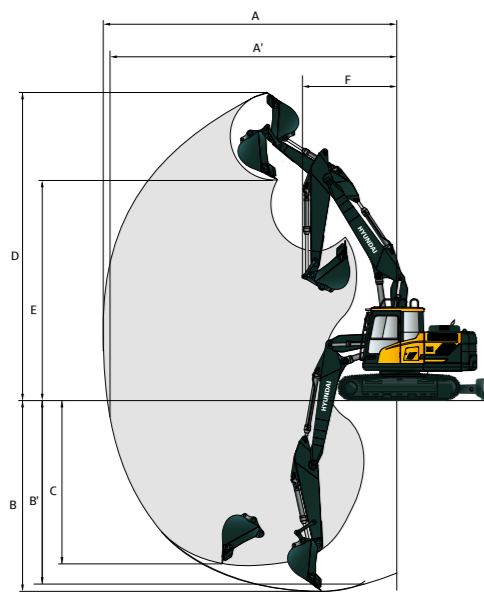

Unit : mm

Boom Length		4900		
Arm Length		1900	2100	2500
A	Max. Digging Reach	8140	8320	8720
A'	Max. Digging Reach on Ground	7990	8170	8580
B	Max. Digging Depth	5080	5270	5680
B'	Max. Digging Depth (8' Level)	4960	5160	5570
C	Max. Vertical Wall Digging Depth*	4460	4620	5080
D	Max. Digging Height	8850	8890	9310
E	Max. Dumping Height	6365	6480	6820
F	Min. Swing Radius	2660	2820	2690

\* This dimension varies with kinds of buckets.

## HX140AHW MONO BOOM DIMENSIONS

4.60 m BOOM and 1.90 m, 2.10 m, 2.50 m, 3.00 m ARM

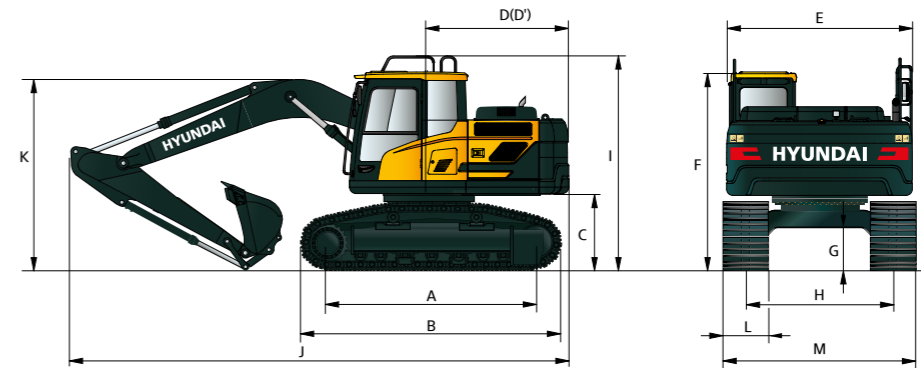

Unit : mm

A	Tumbler Distance	3030
B	Overall Length of Crawler	3770
*C	Ground Clearance of Counter Weight	1205
D	Tail Swing Radius	2345
D'	Rear-End Length	2335
E	Overall Width of Upper Structure	2475
*F	Overall Height of Cab	2860
*G	Min. Ground Clearance	600
H	Track gauge	2040
*I	Overall Height of Guardrail	3110

Boom length		4600			
Arm length		1900	2100	2500	3000
J	Overall Length	7830	7855	7830	7795
K	Overall Height of Boom	2675	2820	2800	3130

L	Track Shoe	700	800	900
M	Overall Width	2740	2840	2940

\* This figure includes the size of grousers.

## HX140AHW MONO BOOM WORKING RANGE

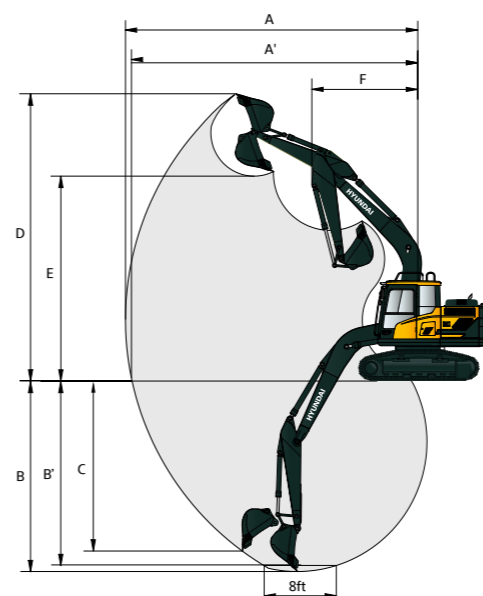

Unit : mm

Boom Length		4600			
Arm Length		1900	2100	2500	3000
A	Max. Digging Reach	7750	7920	8320	8780
A'	Max. Digging Reach on Ground	7590	7760	8170	8640
B	Max. Digging Depth	4915	5115	5515	6015
B'	Max. Digging Depth (8' Level)	4650	4860	5300	5830
C	Max. Vertical Wall Digging Depth*	4470	4660	5065	5570
D	Max. Digging Height	8130	8200	8530	8800
E	Max. Dumping Height	5690	5770	6080	6350
F	Min. Swing Radius	2620	2670	2650	2670

\* This dimension varies with kinds of buckets.

# DIMENSIONS & WORKING RANGE

## HX140AHW 2-PIECE BOOM DIMENSIONS

4.90 m BOOM and 1.90 m, 2.10 m, 2.50 m ARM

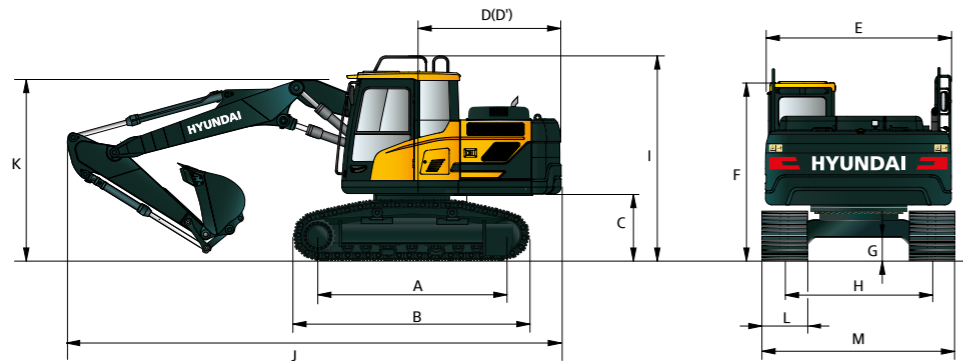

A	Tumbler Distance	3030
B	Overall Length of Crawler	3770
*C	Ground Clearance of Counter Weight	1205
D	Tail Swing Radius	2345
D'	Rear-End Length	2335
E	Overall Width of Upper Structure	2475
*F	Overall Height of Cab	2860
*G	Min. Ground Clearance	600
H	Track gauge	2040
*I	Overall Height of Guardrail	3110

Boom length		4900		
Arm length		1900	2100	2500
J	Overall Length	8170	8180	8155
K	Overall Height of Boom	2805	2900	2925
L	Track Shoe	700	800	900
M	Overall Width	2740	2840	2940

\* This figure includes the size of grousers.

Unit : mm

## HX140AHW 2-PIECE BOOM WORKING RANGE

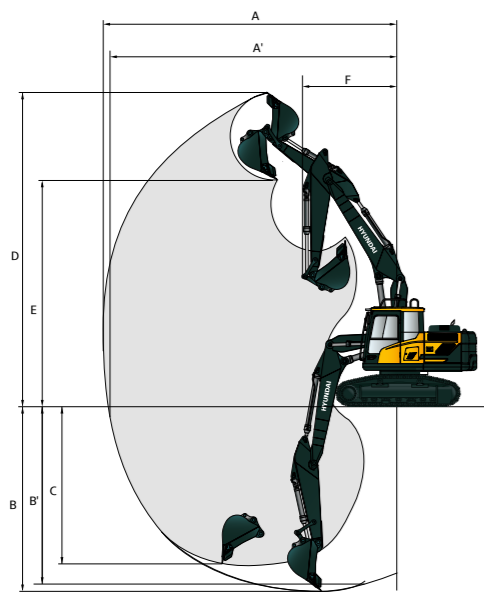

Boom Length		4900		
Arm Length		1900	2100	2500
A	Max. Digging Reach	8140	8320	8720
A'	Max. Digging Reach on Ground	7990	8170	8580
B	Max. Digging Depth	5080	5270	5680
B'	Max. Digging Depth (8° Level)	4960	5160	5570
C	Max. Vertical Wall Digging Depth*	4460	4620	5080
D	Max. Digging Height	8850	8890	9310
E	Max. Dumping Height	6365	6480	6365
F	Min. Swing Radius	2660	2820	2660

\* This dimension varies with kinds of buckets.

# LIFTING CAPACITY

Rating over-front Rating over-side or 360 degrees

## HX140A L MONO BOOM

4.60 m boom, 1.90 m arm equipped with 2100 kg counter weight, 600 mm Triple grouser shoe and without Dozer.

Lift-point height m	kg	Lift-point radius								At max. Reach		
		1.5 m		3.0 m		4.5 m		6.0 m		Capacity	Reach	
										kg	m	
6.0 m	kg					*4200	4150			*3650	*3650	4.73
4.5 m	kg					*4340	4100			*3340	2750	5.80
3.0 m	kg					*5220	3910	3860	2560	*3330	2350	6.35
1.5 m	kg					5810	3700	3770	2480	3350	2220	6.50
0.0 m	kg			*5760	*5760	5680	3580	3710	2430	3480	2280	6.29
-1.5 m	kg	*5710	*5710	*9710	6530	5660	3570			4020	2620	5.68
-3.0 m	kg			*7880	6680	*5100	3680			*5080	3670	4.51

4.60 m boom, 1.90 m arm equipped with 2100 kg counter weight, 600 mm Triple grouser shoe and with Dozer up.

Lift-point height m	kg	Lift-point radius								At max. Reach		
		1.5 m		3.0 m		4.5 m		6.0 m		Capacity	Reach	
										kg	m	
6.0 m	kg					*4200	*4200			*3650	*3650	4.73
4.5 m	kg					*4340	4290			*3340	2890	5.80
3.0 m	kg					*5220	4100	3830	2700	*3330	2470	6.35
1.5 m	kg					5770	3900	3740	2620	3330	2340	6.50
0.0 m	kg			*5760	*5760	5630	3780	3690	2570	3450	2410	6.29
-1.5 m	kg	*5710	*5710	*9710	6870	5610	3760			3990	2760	5.68
-3.0 m	kg			*7880	7030	*5100	3880			*5080	3870	4.51

4.60 m boom, 1.90 m arm equipped with 2100 kg counter weight, 600 mm Triple grouser shoe and with Dozer down.

Lift-point height m	kg	Lift-point radius								At max. Reach		
		1.5 m		3.0 m		4.5 m		6.0 m		Capacity	Reach	
										kg	m	
6.0 m	kg					*4200	*4200			*3650	*3650	4.73
4.5 m	kg					*4340	*4340			*3340	3140	5.80
3.0 m	kg					*5220	4480	*4420	2940	*3330	2690	6.35
1.5 m	kg					*6220	4270	*4790	2860	*3550	2550	6.50
0.0 m	kg			*5760	*5760	*3760	4150	*5000	2800	*4050	2630	6.29
-1.5 m	kg	*5710	*5710	*9710	7690	*6600	4130			*4960	3020	5.68
-3.0 m	kg			*7880	7850	*5100	4250			*5080	4240	4.51

- Lifting capacities are based on ISO 10567.
- Lifting capacity of the HX A-series does not exceed 75% of tipping load with the machine on firm, level ground or 87% of full hydraulic capacity.
- The Lift-point is bucket pivot mounting pin on the arm (without bucket mass).
- (\*) indicates load limited by hydraulic capacity.
- Caution: please be aware of the local regulations and instructions for lifting operations.

# LIFTING CAPACITY

Rating over-front Rating over-side or 360 degrees

## HX140A L MONO BOOM

4.60 m boom, 1.90 m arm equipped with 2400 kg counter weight, 600 mm Triple grouser shoe and without Dozer.

Lift-point height m	Lift-point radius								At max. Reach		
	1.5 m		3.0 m		4.5 m		6.0 m		Capacity	Reach	
6.0 m	kg				*4200	*4200			*3650	*3650	4.73
4.5 m	kg				*4340	4310			*3340	2900	5.80
3.0 m	kg				*5220	4120	4040	2710	*3330	2480	6.35
1.5 m	kg				6080	3910	3950	2630	3510	2350	6.50
0.0 m	kg		*5760	*5760	5950	3790	3890	2580	3640	2420	6.29
-1.5 m	kg	*5710	*5710	*9710	6900	5930	3770		4210	2770	5.68
-3.0 m	kg		*7880	7050	*5100	3890			*5080	3880	4.51

4.60 m boom, 1.90 m arm equipped with 2400 kg counter weight, 600 mm Triple grouser shoe and with Dozer up.

Lift-point height m	Lift-point radius								At max. Reach		
	1.5 m		3.0 m		4.5 m		6.0 m		Capacity	Reach	
6.0 m	kg				*4200	*4200			*3650	*3650	4.73
4.5 m	kg				*4340	*4340			*3340	3040	5.80
3.0 m	kg				*5220	4310	4010	2840	*3330	2610	6.35
1.5 m	kg				6040	4100	3920	2760	3490	2470	6.50
0.0 m	kg		*5760	*5760	5900	3980	3870	2710	3620	2550	6.29
-1.5 m	kg	*5710	*5710	*9710	7240	5880	3970		4180	2920	5.68
-3.0 m	kg		*7880	7400	*5100	4080			*5080	4070	4.51

4.60 m boom, 1.90 m arm equipped with 2400 kg counter weight, 600 mm Triple grouser shoe and with Dozer down.

Lift-point height m	Lift-point radius								At max. Reach		
	1.5 m		3.0 m		4.5 m		6.0 m		Capacity	Reach	
6.0 m	kg				*4200	*4200			*3650	*3650	4.73
4.5 m	kg				*4340	*4340			*3340	3300	5.80
3.0 m	kg				*5220	4700	*4420	3090	*3330	2830	6.35
1.5 m	kg				*6220	4490	*4790	3010	*3550	2690	6.50
0.0 m	kg		*5760	*5760	*6760	4370	*5000	2950	*4050	2780	6.29
-1.5 m	kg	*5710	*5710	*9710	8090	*6600	4350		*4960	3180	5.68
-3.0 m	kg		*7880	*7880	*5100	4470			*5080	4460	4.51

- Lifting capacities are based on ISO 10567.
- Lifting capacity of the HX A-series does not exceed 75% of tipping load with the machine on firm, level ground or 87% of full hydraulic capacity.
- The Lift-point is bucket pivot mounting pin on the arm (without bucket mass).
- (\*) indicates load limited by hydraulic capacity.
- Caution: please be aware of the local regulations and instructions for lifting operations.

Rating over-front Rating over-side or 360 degrees

## HX140A L MONO BOOM

4.60 m boom, 2.10 m arm equipped with 2100 kg counter weight, 600 mm Triple grouser shoe and without Dozer.

Lift-point height m	Lift-point radius								At max. Reach			
	1.5 m		3.0 m		4.5 m		6.0 m		Capacity	Reach		
6.0 m	kg					*3910	*3910		*3480	*3480	4.97	
4.5 m	kg					*4130	4120		*3220	2610	5.99	
3.0 m	kg				*7310	7230	*5030	3920	3860	2560	6.52	
1.5 m	kg						5820	3700	3770	2480	6.67	
0.0 m	kg			*6170	*6170	5660	3570	3700	2410	3330	2180	6.47
-1.5 m	kg	*5500	*5500	*9880	6480	5630	3540			3810	2480	5.88
-3.0 m	kg			*8240	6620	*5480	3630			*5010	3380	4.75

4.60 m boom, 2.10 m arm equipped with 2100 kg counter weight, 600 mm Triple grouser shoe and with Dozer up.

Lift-point height m	Lift-point radius								At max. Reach			
	1.5 m		3.0 m		4.5 m		6.0 m		Capacity	Reach		
6.0 m	kg					*3910	*3910		*3480	*3480	4.97	
4.5 m	kg					*4130	*4130		*3220	2750	5.99	
3.0 m	kg				*7310	*7310	*5030	4110	3830	2700	6.52	
1.5 m	kg						5770	3900	3740	2610	6.67	
0.0 m	kg			*6170	*6170	5620	3760	3670	2550	3300	2310	6.47
-1.5 m	kg	*5500	*5500	*9880	6820	5580	3730			3780	2620	5.88
-3.0 m	kg			*8240	6960	*5480	3820			*5010	3560	4.75

4.60 m boom, 2.10 m arm equipped with 2100 kg counter weight, 600 mm Triple grouser shoe and with Dozer down.

Lift-point height m	Lift-point radius								At max. Reach			
	1.5 m		3.0 m		4.5 m		6.0 m		Capacity	Reach		
6.0 m	kg					*3910	*3910		*3480	*3480	4.97	
4.5 m	kg					*4130	*4130		*3220	2990	5.99	
3.0 m	kg				*7310	7230	*5030	4500	*4280	2940	6.52	
1.5 m	kg						*6080	4270	*4690	2850	6.67	
0.0 m	kg			*6170	*6170	*6700	4140	*4960	2790	*3920	2520	6.47
-1.5 m	kg	*5500	*5500	*9880	7640	*6640	4110			*4820	2860	5.88
-3.0 m	kg			*8240	7790	*5480	4200			*5010	3900	4.75

- Lifting capacities are based on ISO 10567.
- Lifting capacity of the HX A-series does not exceed 75% of tipping load with the machine on firm, level ground or 87% of full hydraulic capacity.
- The Lift-point is bucket pivot mounting pin on the arm (without bucket mass).
- (\*) indicates load limited by hydraulic capacity.
- Caution: please be aware of the local regulations and instructions for lifting operations.

# LIFTING CAPACITY

Rating over-front Rating over-side or 360 degrees

Rating over-front Rating over-side or 360 degrees

## HX140A L MONO BOOM

4.60 m boom, 2.10 m arm equipped with 2400 kg counter weight, 600 mm Triple grouser shoe and without Dozer.

Lift-point height m	Lift-point radius								At max. Reach		
	1.5 m		3.0 m		4.5 m		6.0 m		Capacity	Reach	
6.0 m	kg				*3910	*3910			*3480	*3480	4.97
4.5 m	kg				*4130	*4130			*3220	2760	5.99
3.0 m	kg		*7310	*7310	*5030	4130	4040	2710	*3230	2380	6.52
1.5 m	kg				*6080	3910	3950	2620	3380	2250	6.67
0.0 m	kg		*6170	*6170	5930	3780	3880	2560	3490	2320	6.47
-1.5 m	kg	*5500	*5500	*9880	6850	5900	3750		3990	2630	5.88
-3.0 m	kg		*8240	6990	*5480	3830			*5010	3570	4.75

4.60 m boom, 2.10 m arm equipped with 2400 kg counter weight, 600 mm Triple grouser shoe and with Dozer up.

Lift-point height m	Lift-point radius								At max. Reach		
	1.5 m		3.0 m		4.5 m		6.0 m		Capacity	Reach	
6.0 m	kg				*3910	*3910			*3480	*3480	4.97
4.5 m	kg				*4130	*4130			*3220	2890	5.99
3.0 m	kg		*7310	*7310	*5030	4320	4010	2840	*3230	2500	6.52
1.5 m	kg				6040	4100	3920	2750	3350	2370	6.67
0.0 m	kg		*6170	*6170	5890	3970	3850	2690	3460	2440	6.47
-1.5 m	kg	*5500	*5500	*9880	7190	5850	3940		3960	2770	5.88
-3.0 m	kg		*8240	7330	*5480	4030			*5010	3750	4.75

4.60 m boom, 2.10 m arm equipped with 2400 kg counter weight, 600 mm Triple grouser shoe and with Dozer down.

Lift-point height m	Lift-point radius								At max. Reach		
	1.5 m		3.0 m		4.5 m		6.0 m		Capacity	Reach	
6.0 m	kg				*3910	*3910			*3480	*3480	4.97
4.5 m	kg				*4130	*4130			*3220	3140	5.99
3.0 m	kg		*7310	*7310	*5030	4720	*4280	3090	*3230	2720	6.52
1.5 m	kg				*6080	4490	*4690	3000	*3440	2580	6.67
0.0 m	kg		*6170	*6170	*6700	4350	*4960	2940	*3920	2660	6.47
-1.5 m	kg	*5500	*5500	*9880	8030	*6640	4320		*4820	3020	5.88
-3.0 m	kg		*8240	8180	*5480	4410			*5010	4100	4.75

- Lifting capacities are based on ISO 10567.
- Lifting capacity of the HX A-series does not exceed 75% of tipping load with the machine on firm, level ground or 87% of full hydraulic capacity.
- The Lift-point is bucket pivot mounting pin on the arm (without bucket mass).
- (\*) indicates load limited by hydraulic capacity.
- Caution: please be aware of the local regulations and instructions for lifting operations.

## HX140A L MONO BOOM

4.60 m boom, 2.50 m arm equipped with 2100 kg counter weight, 600 mm Triple grouser shoe and without Dozer.

Lift-point height m	Lift-point radius								At max. Reach			
	1.5 m		3.0 m		4.5 m		6.0 m		Capacity	Reach		
6.0 m	kg					*3400	*3400		*2400	*2400	5.50	
4.5 m	kg					*3700	*3700	*3500	2640	*2220	*2220	6.44
3.0 m	kg			*6380	*6380	*4640	3950	3870	2560	*2210	2040	6.93
1.5 m	kg			*7060	6690	*5760	3710	3760	2460	*2320	1930	7.07
0.0 m	kg			*6550	6410	5640	3540	3670	2380	*2600	1970	6.88
-1.5 m	kg	*4890	*4890	*10080	6390	5580	3490	3650	2360	*3170	2210	6.34
-3.0 m	kg	*9020	*9020	*8830	6500	5630	3540			4410	2840	5.31

4.60 m boom, 2.50 m arm equipped with 2100 kg counter weight, 600 mm Triple grouser shoe and with Dozer up.

Lift-point height m	Lift-point radius								At max. Reach			
	1.5 m		3.0 m		4.5 m		6.0 m		Capacity	Reach		
6.0 m	kg					*3400	*3400		*2400	*2400	5.50	
4.5 m	kg					*3700	*3700	*3500	2770	*2220	*2220	6.44
3.0 m	kg			*6380	*6380	*4640	4140	3840	2700	*2210	2150	6.93
1.5 m	kg			*7060	7030	*5760	3900	3730	2600	*2320	2040	7.07
0.0 m	kg			*6550	*6550	5600	3740	3640	2520	*2600	2090	6.88
-1.5 m	kg	*4890	*4890	*10080	6730	5530	3680	3620	2500	*3170	2330	6.34
-3.0 m	kg	*9020	*9020	*8830	6840	5590	3730			4380	3000	5.31

4.60 m boom, 2.50 m arm equipped with 2100 kg counter weight, 600 mm Triple grouser shoe and with Dozer down.

Lift-point height m	Lift-point radius								At max. Reach			
	1.5 m		3.0 m		4.5 m		6.0 m		Capacity	Reach		
6.0 m	kg					*3400	*3400		*2400	*2400	5.50	
4.5 m	kg					*3700	*3700	*3500	3010	*2220	*2220	6.44
3.0 m	kg			*6380	*6380	*4640	4530	*4010	2940	*2210	*2210	6.93
1.5 m	kg			*7060	*7060	*5760	4280	*4490	2840	*2320	2230	7.07
0.0 m	kg			*6550	*6550	*6540	4110	*4860	2760	*2600	2280	6.88
-1.5 m	kg	*4890	*4890	*10080	7550	*6680	4060	*4830	2730	*3170	2550	6.34
-3.0 m	kg	*9020	*9020	*8830	7660	*5930	4110			*4580	3290	5.31

- Lifting capacities are based on ISO 10567.
- Lifting capacity of the HX A-series does not exceed 75% of tipping load with the machine on firm, level ground or 87% of full hydraulic capacity.
- The Lift-point is bucket pivot mounting pin on the arm (without bucket mass).
- (\*) indicates load limited by hydraulic capacity.
- Caution: please be aware of the local regulations and instructions for lifting operations.



# LIFTING CAPACITY

Rating over-front Rating over-side or 360 degrees

Rating over-front Rating over-side or 360 degrees

## HX140A L MONO BOOM

4.60 m boom, 3.00 m arm equipped with 2400 kg counter weight, 600 mm Triple grouser shoe and without Dozer.

Lift-point height m		Lift-point radius										At max. Reach				
		1.5 m		3.0 m		4.5 m		6.0 m		7.5 m		Capacity		Reach		
														kg	m	
7.5 m	kg					*2600	*2600							*2390	*2390	4.59
6.0 m	kg							*2240	*2240					*2010	*2010	6.08
4.5 m	kg							*3290	2820					*1880	*1880	6.94
3.0 m	kg			*5260	*5260	*4140	*4140	*3680	2740					*1880	*1880	7.40
1.5 m	kg			*8410	7240	*5360	3970	3960	2620	*2130	1880			*1980	1870	7.53
0.0 m	kg			*7190	6820	5940	3770	3850	2530					*2190	1900	7.36
-1.5 m	kg	*4380	*4380	*9290	6720	5830	3680	3800	2480					*2610	2080	6.85
-3.0 m	kg	*7550	*7550	*9450	6790	5840	3690							*3560	2560	5.91
-4.5 m	kg			*6970	*6970									*4530	4130	4.29

4.60 m boom, 3.00 m arm equipped with 2400 kg counter weight, 600 mm Triple grouser shoe and with Dozer up.

Lift-point height m		Lift-point radius										At max. Reach				
		1.5 m		3.0 m		4.5 m		6.0 m		7.5 m		Capacity		Reach		
														kg	m	
7.5 m	kg					*2600	*2600							*2390	*2390	4.59
6.0 m	kg							*2240	*2240					*2010	*2010	6.08
4.5 m	kg							*3290	2960					*1880	*1880	6.94
3.0 m	kg			*5260	*5260	*4140	*4140	*3680	2870					*1880	*1880	7.40
1.5 m	kg			*8410	7580	*5360	4160	3930	2760	*2130	1980			*1980	1970	7.53
0.0 m	kg			*7190	7170	5890	3960	3820	2660					*2190	2000	7.36
-1.5 m	kg	*4380	*4380	*9290	7070	5790	3870	3770	2610					*2610	2200	6.85
-3.0 m	kg	*7550	*7550	*9450	7130	5800	3880							*3560	2700	5.91
-4.5 m	kg			*6970	*6970									*4530	4330	4.29

4.60 m boom, 3.00 m arm equipped with 2400 kg counter weight, 600 mm Triple grouser shoe and with Dozer down.

Lift-point height m		Lift-point radius										At max. Reach				
		1.5 m		3.0 m		4.5 m		6.0 m		7.5 m		Capacity		Reach		
														kg	m	
7.5 m	kg					*2600	*2600							*2390	*2390	4.59
6.0 m	kg							*2240	*2240					*2010	*2010	6.08
4.5 m	kg							*3290	3210					*1880	*1880	6.94
3.0 m	kg			*5260	*5260	*4140	*4140	*3680	3120					*1880	*1880	7.40
1.5 m	kg			*8410	*8410	*5360	4560	*4240	3010	*2130	*2130			*1980	*1980	7.53
0.0 m	kg			*7190	*7190	*6310	4350	*4710	2910					*2190	2190	7.36
-1.5 m	kg	*4380	*4380	*9290	7910	*6680	4260	*4880	2860					*2610	2400	6.85
-3.0 m	kg	*7550	*7550	*9450	7970	*6290	4270							*3560	2950	5.91
-4.5 m	kg			*6970	*6970									*4530	*4530	4.29

- Lifting capacities are based on ISO 10567.
- Lifting capacity of the HX A-series does not exceed 75% of tipping load with the machine on firm, level ground or 87% of full hydraulic capacity.
- The Lift-point is bucket pivot mounting pin on the arm (without bucket mass).
- (\*) indicates load limited by hydraulic capacity.
- Caution: please be aware of the local regulations and instructions for lifting operations.

## HX140A L 2-PIECE BOOM

4.90 m boom, 1.90 m arm equipped with 2400 kg counter weight, 600 mm Triple grouser shoe and without Dozer.

Lift-point height m		Lift-point radius						At max. Reach								
		3.0 m		4.5 m		6.0 m		Capacity		Reach						
										kg	m					
7.5 m	kg													*4290	*4290	3.42
6.0 m	kg					*3680	*3680							*3730	3390	5.26
4.5 m	kg	*4930	*4930	*4060	*4060	*3830	2740							*3420	2560	6.24
3.0 m	kg			*5030	4050	4030	2670							3350	2230	6.75
1.5 m	kg			6020	3820	3920	2570							3200	2110	6.89
0.0 m	kg			5880	3700	3850	2510							3300	2170	6.70
-1.5 m	kg	*8200	6780	5860	3680	3850	2510							3750	2450	6.13

4.90 m boom, 1.90 m arm equipped with 2400 kg counter weight, 600 mm Triple grouser shoe and with Dozer up.



Lift-point height m		Lift-point radius						At max. Reach								
		3.0 m		4.5 m		6.0 m		Capacity		Reach						
										kg	m					
7.5 m	kg													*4290	*4290	3.42
6.0 m	kg					*3680	*3680							*3730	3550	5.26
4.5 m	kg	*4930	*4930	*4060	*4060	*3830	2880							*3420	2690	6.24
3.0 m	kg			*5030	4240	4000	2810							3330	2340	6.75
1.5 m	kg			5970	4010	3890	2710							3180	2230	6.89
0.0 m	kg			5830	3890	3820	2640							3280	2290	6.70
-1.5 m	kg	*8200	7120	5820	3870	3830	2650							3720	2580	6.13

4.90 m boom, 1.90 m arm equipped with 2400 kg counter weight, 600 mm Triple grouser shoe and with Dozer down.

Lift-point height m		Lift-point radius						At max. Reach								
		3.0 m		4.5 m		6.0 m		Capacity		Reach						
										kg	m					
7.5 m	kg													*4290	*4290	3.42
6.0 m	kg					*3680	*3680							*3730	*3730	5.26
4.5 m	kg	*4930	*4930	*4060	*4060	*3830	3130							*3420	2930	6.24
3.0 m	kg			*5030	4640	*4120	3060							*3370	2550	6.75
1.5 m	kg			*6040	4400	*4550	2960							*3530	2430	6.89
0.0 m	kg			*6580	4280	*4850	2890							*3910	2500	6.70
-1.5 m	kg	*8200	7970	*6530	4260	*4710	2900							*4550	2820	6.13

- Lifting capacities are based on ISO 10567.
- Lifting capacity of the HX A-series does not exceed 75% of tipping load with the machine on firm, level ground or 87% of full hydraulic capacity.
- The Lift-point is bucket pivot mounting pin on the arm (without bucket mass).
- (\*) indicates load limited by hydraulic capacity.
- Caution: please be aware of the local regulations and instructions for lifting operations.









# LIFTING CAPACITY

 Rating over-front  Rating over-side or 360 degrees









 Rating over-front  Rating over-side or 360 degrees

## HX140A L 2-PIECE BOOM









4.90 m boom, 2.10 m arm equipped with 2400 kg counter weight, 600 mm Triple grouser shoe and without Dozer.

Lift-point height m		Lift-point radius						At max. Reach		
		3.0 m		4.5 m		6.0 m		Capacity	Reach	
										m
7.5 m	kg							*3990	*3990	3.77
6.0 m	kg			*3460	*3460			*3550	3180	5.50
4.5 m	kg	*4560	*4560	*3870	*3870	*3660	2750	*3280	2440	6.44
3.0 m	kg			*4840	4060	*3990	2670	3220	2140	6.93
1.5 m	kg			*5890	3820	3910	2570	3070	2030	7.07
0.0 m	kg			5860	3880	3830	2490	3160	2080	6.88
-1.5 m	kg	*7960	6720	5830	3650	3820	2480	3560	2330	6.33
-3.0 m	kg			*5810	3730					

4.90 m boom, 2.10 m arm equipped with 2400 kg counter weight, 600 mm Triple grouser shoe and with Dozer up.

Lift-point height m		Lift-point radius						At max. Reach		
		3.0 m		4.5 m		6.0 m		Capacity	Reach	
										m
7.5 m	kg							*3990	*3990	3.77
6.0 m	kg			*3460	*3460			*3550	3320	5.50
4.5 m	kg	*4560	*4560	*3870	*3870	*3660	2890	*3280	2570	6.44
3.0 m	kg			*4840	4260	*3990	2810	3190	2250	6.93
1.5 m	kg			*5890	4010	3890	2700	3050	2140	7.07
0.0 m	kg			5820	3870	3800	2630	3140	2190	6.88
-1.5 m	kg	*7960	7060	5790	3850	3790	2620	3530	2450	6.33
-3.0 m	kg			*5810	3920					









4.90 m boom, 2.10 m arm equipped with 2400 kg counter weight, 600 mm Triple grouser shoe and with Dozer down.

Lift-point height m		Lift-point radius						At max. Reach		
		3.0 m		4.5 m		6.0 m		Capacity	Reach	
										m
7.5 m	kg							*3990	*3990	3.77
6.0 m	kg			*3460	*3460			*3550	*3550	5.50
4.5 m	kg	*4560	*4560	*3870	*3870	*3660	3140	*3280	2790	6.44
3.0 m	kg			*4840	4660	*3990	3060	3260	2450	6.93
1.5 m	kg			*5890	4400	*4460	2950	*3410	2330	7.07
0.0 m	kg			*6510	4260	*4790	2880	*3780	2390	6.88
-1.5 m	kg	*7960	7910	*6550	4230	*4760	2870	*4410	2680	6.33
-3.0 m	kg			*5810	4310					









- Lifting capacities are based on ISO 10567.
- Lifting capacity of the HX A-series does not exceed 75% of tipping load with the machine on firm, level ground or 87% of full hydraulic capacity.
- The Lift-point is bucket pivot mounting pin on the arm (without bucket mass).
- (\*) indicates load limited by hydraulic capacity.
- Caution: please be aware of the local regulations and instructions for lifting operations.

## HX140A L 2-PIECE BOOM









4.90 m boom, 2.50 m arm equipped with 2400 kg counter weight, 600 mm Triple grouser shoe and without Dozer.

Lift-point height m		Lift-point radius						At max. Reach		
		3.0 m		4.5 m		6.0 m		Capacity	Reach	
										m
7.5 m	kg							*2990	*2990	4.50
6.0 m	kg			*3030	*3030	*2530	*2530	*2460	*2460	6.01
4.5 m	kg			*3480	*3480	*3350	2770	*2280	2190	6.88
3.0 m	kg			*4470	4100	*3740	2680	*2250	1940	7.34
1.5 m	kg			*5580	3830	3910	2560	*2330	1850	7.48
0.0 m	kg	*3860	*3860	5840	3650	3810	2470	*2550	1880	7.30
-1.5 m	kg	*7200	6610	5780	3600	3770	2430	*2980	2080	6.78
-3.0 m	kg	*8920	6740	5830	3650			*3950	2590	5.84

4.90 m boom, 2.50 m arm equipped with 2400 kg counter weight, 600 mm Triple grouser shoe and with Dozer up.

Lift-point height m		Lift-point radius						At max. Reach		
		3.0 m		4.5 m		6.0 m		Capacity	Reach	
										m
7.5 m	kg							*2990	*2990	4.50
6.0 m	kg			*3030	*3030	*2530	*2530	*2460	*2460	6.01
4.5 m	kg			*3480	*3480	*3350	2910	*2280	*2280	6.88
3.0 m	kg			*4470	4290	*3740	2810	*2250	2050	7.34
1.5 m	kg			*5580	4020	3880	2690	*2330	1950	7.48
0.0 m	kg	*3860	*3860	5800	3850	3780	2600	*2550	1990	7.30
-1.5 m	kg	*7200	6960	5730	3790	3740	2570	*2980	2200	6.78
-3.0 m	kg	*8920	7080	5790	3840			*3950	2730	5.84

4.90 m boom, 2.50 m arm equipped with 2400 kg counter weight, 600 mm Triple grouser shoe and with Dozer down.

Lift-point height m		Lift-point radius						At max. Reach		
		3.0 m		4.5 m		6.0 m		Capacity	Reach	
										m
7.5 m	kg							*2990	*2990	4.50
6.0 m	kg			*3030	*3030	*2530	*2530	*2460	*2460	6.01
4.5 m	kg			*3480	*3480	*3350	3160	*2280	*2280	6.88
3.0 m	kg			*4470	*4470	*3740	3060	*2250	2230	7.34
1.5 m	kg			*5580	4420	*4260	2940	*2330	2130	7.48
0.0 m	kg	*3860	*3860	*6340	4240	*4670	2850	*2550	2180	7.30
-1.5 m	kg	*7200	*7200	*6540	4180	*4780	2820	*2980	2410	6.78
-3.0 m	kg	*8920	7930	*6070	4230			*3950	2990	5.84

- Lifting capacities are based on ISO 10567.
- Lifting capacity of the HX A-series does not exceed 75% of tipping load with the machine on firm, level ground or 87% of full hydraulic capacity.
- The Lift-point is bucket pivot mounting pin on the arm (without bucket mass).
- (\*) indicates load limited by hydraulic capacity.
- Caution: please be aware of the local regulations and instructions for lifting operations.



# LIFTING CAPACITY

Rating over-front Rating over-side or 360 degrees

Rating over-front Rating over-side or 360 degrees

## HX140AHW MONO BOOM

4.60 m boom, 1.90 m arm equipped with 2100 kg counter weight, 600 mm Triple grouser shoe.

Lift-point height m	Lift-point radius								At max. Reach		
	1.5 m		3.0 m		4.5 m		6.0 m		Capacity	Reach	
6.0 m	kg				*4200	*4200			*3650	*3650	4.73
4.5 m	kg				*4340	*4340			*3340	3230	5.80
3.0 m	kg				*5220	4590	*4420	3020	*3330	2770	6.35
1.5 m	kg				*6220	4380	4380	2940	*3550	2630	6.50
0.0 m	kg		*5760	*5760	6600	4260	4320	2890	4040	2710	6.29
-1.5 m	kg	*5710	*5710	*9710	7800	6580	4240		4670	3110	5.68
-3.0 m	kg		*7880	*7880	*5100	4360			*5080	4350	4.51

4.60 m boom, 1.90 m arm equipped with 2400 kg counter weight, 600 mm Triple grouser shoe.

Lift-point height m	Lift-point radius								At max. Reach		
	1.5 m		3.0 m		4.5 m		6.0 m		Capacity	Reach	
6.0 m	kg				*4200	*4200			*3650	*3650	4.73
4.5 m	kg				*4340	*4340			*3340	*3340	5.80
3.0 m	kg				*5220	4800	*4420	3170	*3330	2910	6.35
1.5 m	kg				*6220	4590	4560	3090	*3550	2760	6.50
0.0 m	kg		*5760	*5760	*6760	4470	4500	3040	*4050	2850	6.29
-1.5 m	kg	*5710	*5710	*9710	8180	*6600	4450		4870	3270	5.68
-3.0 m	kg		*7880	*7880	*5100	4570			*5080	4560	4.51

4.60 m boom, 2.10 m arm equipped with 2100 kg counter weight, 600 mm Triple grouser shoe.

Lift-point height m	Lift-point radius								At max. Reach		
	1.5 m		3.0 m		4.5 m		6.0 m		Capacity	Reach	
6.0 m	kg				*3910	*3910			*3480	*3480	4.97
4.5 m	kg				*4130	*4130			*3220	3070	5.99
3.0 m	kg				*7310	*7310	*5030	4600	*4280	3020	6.52
1.5 m	kg				*6080	4380	4370	2930	*3440	2530	6.67
0.0 m	kg		*6170	*6170	6580	4240	4300	2870	3870	2600	6.47
-1.5 m	kg	*5500	*5500	*9880	7750	6550	4210		4430	2950	5.88
-3.0 m	kg		*8240	7890	*5480	4300			*5010	4000	4.75

4.60 m boom, 2.10 m arm equipped with 2400 kg counter weight, 600 mm Triple grouser shoe.

Lift-point height m	Lift-point radius								At max. Reach		
	1.5 m		3.0 m		4.5 m		6.0 m		Capacity	Reach	
6.0 m	kg				*3910	*3910			*3480	*3480	4.97
4.5 m	kg				*4130	*4130			*3220	*3220	5.99
3.0 m	kg				*7310	*7310	*5030	4810	*4280	3170	6.52
1.5 m	kg				*6080	4590	4550	3080	*3440	2660	6.67
0.0 m	kg		*6170	*6170	*6700	4450	4490	3020	*3920	2730	6.47
-1.5 m	kg	*5500	*5500	*9880	8130	*6640	4420		4620	3100	5.88
-3.0 m	kg		*8240	*8240	*5480	4510			*5010	4200	4.75

- Lifting capacities are based on ISO 10567.
- Lifting capacity of the HX A-series does not exceed 75% of tipping load with the machine on firm, level ground or 87% of full hydraulic capacity.
- The Lift-point is bucket pivot mounting pin on the arm (without bucket mass).
- (\*) indicates load limited by hydraulic capacity.
- Caution: please be aware of the local regulations and instructions for lifting operations.

## HX140AHW MONO BOOM

4.60 m boom, 2.50 m arm equipped with 2100 kg counter weight, 600 mm Triple grouser shoe.

Lift-point height m	Lift-point radius								At max. Reach				
	1.5 m		3.0 m		4.5 m		6.0 m		Capacity	Reach			
6.0 m	kg					*3400	*3400		*2400	*2400	5.50		
4.5 m	kg					*3700	*3700	*3500	3090	*2220	*2220	6.44	
3.0 m	kg				*6380	*6380	*4640	4630	*4010	3020	*2210	*2210	6.93
1.5 m	kg				*7060	*7060	*5760	4390	4360	2920	*2320	2300	7.07
0.0 m	kg			*6550	*6550	*6540	4220	4280	2840		*2600	2360	6.88
-1.5 m	kg	*4890	*4890	*10080	7660	6500	4160	4250	2820		*3170	2630	6.34
-3.0 m	kg	*9020	*9020	*8830	7770	*5930	4210				*4580	3380	5.31

4.60 m boom, 2.50 m arm equipped with 2400 kg counter weight, 600 mm Triple grouser shoe.

Lift-point height m	Lift-point radius								At max. Reach				
	1.5 m		3.0 m		4.5 m		6.0 m		Capacity	Reach			
6.0 m	kg					*3400	*3400		*2400	*2400	5.50		
4.5 m	kg					*3700	*3700	*3500	3240	*2220	*2220	6.44	
3.0 m	kg				*6380	*6380	*4640	*4640	*4010	3170	*2210	*2210	6.93
1.5 m	kg				*7060	*7060	*5760	4600	*4490	3070	*2320	*2320	7.07
0.0 m	kg			*6550	*6550	*6540	4430	4460	2990		*2600	2480	6.88
-1.5 m	kg	*4890	*4890	*10080	8040	*6680	4370	4430	2970		*3170	2770	6.34
-3.0 m	kg	*9020	*9020	*8830	8150	*5930	4430				*4580	3550	5.31

4.60 m boom, 3.00 m arm equipped with 2100 kg counter weight, 600 mm Triple grouser shoe.

Lift-point height m	Lift-point radius								At max. Reach						
	1.5 m		3.0 m		4.5 m		6.0 m		7.5 m		Capacity	Reach			
7.5 m	kg					*2600	*2600				*2390	*2390	4.59		
6.0 m	kg							*2240	*2240		*2010	*2010	6.08		
4.5 m	kg							*3290	3140		*1880	*1880	6.94		
3.0 m	kg				*5260	*5260	*4140	*4140	*3680	3050	*1880	*1880	7.40		
1.5 m	kg				*8410	8150	*5360	4440	*4240	2940	*2130	2120	*1980	*1980	7.53
0.0 m	kg				*7190	*7190	*6310	4240	4280	2840			*2190	2140	7.36
-1.5 m	kg	*4380	*4380	*9290	7620	6480	4140	4220	2790				*2610	2350	6.85
-3.0 m	kg	*7550	*7550	*9450	7690	*6290	4160						*3560	2880	5.91
-4.5 m	kg				*6970	*6970							*4530	*4530	4.29

4.60 m boom, 3.00 m arm equipped with 2400 kg counter weight, 600 mm Triple grouser shoe.

Lift-point height m	Lift-point radius								At max. Reach						
	1.5 m		3.0 m		4.5 m		6.0 m		7.5 m		Capacity	Reach			
7.5 m	kg					*2600	*2600				*2390	*2390	4.59		
6.0 m	kg							*2240	*2240		*2010	*2010	6.08		
4.5 m	kg							*3290	3290		*1880	*1880	6.94		
3.0 m	kg				*5260	*5260	*4140	*4140	*3680	3200	*1880	*1880	7.40		
1.5 m	kg				*8410	*8410	*5360	4650	*4240	3090	*2130	*2130	*1980	*1980	7.53
0.0 m	kg				*7190	*7190	*6310	4450	4460	2990			*2190	*2190	7.36
-1.5 m	kg	*4380	*4380	*9290	8000	*6680	4360	4410	2940				*2610	2470	6.85
-3.0 m	kg	*7550	*7550	*9450	8070	*6290	4370						*3560	3030	5.91
-4.5 m	kg				*6970	*6970							*4530	*4530	4.29

- Lifting capacities are based on ISO 10567.
- Lifting capacity of the HX A-series does not exceed 75% of tipping load with the machine on firm, level ground or 87% of full hydraulic capacity.
- The Lift-point is bucket pivot mounting pin on the arm (without bucket mass).
- (\*) indicates load limited by hydraulic capacity.
- Caution: please be aware of the local regulations and instructions for lifting operations.

# BUCKET SELECTION GUIDE & DIGGING FORCE

## BUCKETS

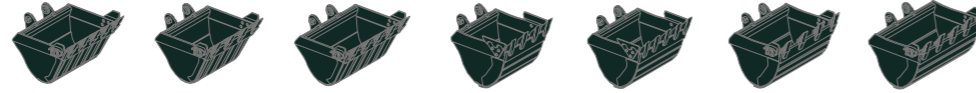

SAE heaped m³	0.58	0.52	0.65	◆ 0.50	◆ 0.61	0.66	0.77
---------------	------	------	------	--------	--------	------	------

Capacity m³		Width mm		Weight kg	Tooth EA	Recommendation mm														
SAE Heaped	CECE Heaped	Without Side Cutters	With Side Cutters			4100 Mono Boom			4600 Mono Boom			4940 2PC Boom								
1900 Arm	2100 Arm	1900 Arm	2100 Arm	2500 Arm	3000 Arm	1900 Arm	2100 Arm	2500 Arm	1900 Arm	2100 Arm	2500 Arm									
<b>Counterweight</b>					<b>2100 kg</b>															
0.58	0.50	950	1110	438	5	●	●	●	●	○	■									
0.52	0.46	870	1020	406	4	●	●	●	●	○	○									
0.65	0.56	1060	1210	459	5	●	●	○	○	■	■									
◆ 0.50	0.45	762	800	439	4	●	●	●	●	●	○									
◆ 0.61	0.54	914	952	490	5	●	●	●	○	○	■									
0.66	0.58	1050	1110	493	4	●	●	○	○	■	▲									
0.77	0.68	1200	1260	543	5	○	○	■	■	▲	▲									
<b>Counterweight</b>					<b>2400 kg</b>									<b>2400 kg</b>						
0.58	0.50	950	1110	438	5	●	●	●	●	●	○	●	●	○						
0.52	0.46	870	1020	406	4	●	●	●	●	●	■	●	●	●						
0.65	0.56	1060	1210	459	5	●	●	●	●	○	○	○	○	■						
◆ 0.50	0.45	762	800	439	4	●	●	●	●	●	●	●	●	●						
◆ 0.61	0.54	914	952	490	5	●	●	●	●	○	■	○	○	■						
0.66	0.58	1050	1110	493	4	●	●	●	○	○	■	○	■	■						
0.77	0.68	1200	1260	543	5	●	○	○	■	■	▲	■	▲	▲						

◆ Hammerless tooth bucket

- Applicable for materials with density of 2100 kg/m³ or less
- Applicable for materials with density of 1800 kg/m³ or less
- Applicable for materials with density of 1500 kg/m³ or less
- ▲ Applicable for materials with density of 1200 kg/m³ or less
- X Not Recommended

## DIGGING FORCE

Boom	Length	mm	4600 Mono Boom				4100 Mono Boom		4900 Mono Boom			Remark
			992				937		1396			
Arm	Length	mm	1900	2100	2500	3000	1900	2100	1900	2100	2500	
			Weight	kg	591	621	681	716	591	621	591	
Bucket Digging Force	SAE	kN	88 [95]	88 [95]	88 [95]	88 [95]	88 [95]	88 [95]	88 [95]	88 [95]	88 [95]	[ ] : Power Boost
		kgf	8958 [9730]	8960 [9730]	8960 [9730]	8958 [9720]	8958 [9730]	8958 [9730]	8958 [9730]	8960 [9730]	8960 [9730]	
		ISO	kN	103 [112]	103 [112]	103 [112]	103 [112]	103 [112]	103 [112]	103 [112]	103 [112]	
Arm Crowd Force	SAE	kN	77 [83]	74 [80]	63 [68]	56 [61]	77 [83]	74 [80]	77 [83]	74 [80]	63 [68]	
		kgf	7815 [8490]	7506 [8150]	6396 [6940]	5711 [6200]	7815 [8490]	7506 [8150]	7815 [8490]	7506 [8150]	6396 [6940]	
		ISO	kN	81 [88]	77 [84]	65 [71]	58 [63]	81 [88]	77 [84]	81 [88]	77 [84]	
		kgf	8213 [8920]	7863 [8540]	6665 [7240]	5924 [6430]	8213 [8920]	7863 [8540]	8215 [8920]	7864 [8540]	6666 [7240]	

Note: Boom weight includes arm cylinder, piping, and pin  
 Arm weight includes bucket cylinder, linkage, and pin

# STANDARD/OPTIONAL EQUIPMENT

ENGINE	STD	OPT
Engine Auto Idle	●	
Engine Auto Shutdown Control	●	
Emergency Engine Stop Switch	●	

HYDRAULIC SYSTEM	STD	OPT
3-Power Mode, 2-Work Mode, User Mode	●	
Variable Power Control	●	
EPIC (Electric Pump Independent Control)	●	
Attachment Mode Flow Control	●	
Hyundai Bio Hydraulic oil (HBHO)		●

CAB & INTERIOR	STD	OPT
Rise-Up Type Windshield Wiper	●	
Radio / USB Player	●	
Handsfree Mobile Phone System with USB	●	
12V Power Outlet (24V DC to 12V DC converter)	●	
Electric Horn	●	
All-Weather Steel Cab with 360° Visibility	●	
Safety glass - Tempered glass	●	
Safety glass - Tempered glass with front laminated glass		●
Sliding Fold-In Front Window	●	
Sliding Side Window (LH)	●	
Lockable Door	●	
Hot & Cool Box	●	
Storage Compartment	●	
Ashtray & Cigar Lighter		●
Transparent Cabin Roof-Cover	●	
Sun Visor	●	
Door And Cab Locks, One Key	●	
Mechanical Suspension Seat With Heater	●	
Pilot-Operated Slidable Joystick	●	
Console Box Height Adjust System	●	
Air Conditioner & Heater	●	
Defroster	●	
Starting Aid (Air Grid Heater) for Cold Weather	●	
8" LCD Display	●	
Engine Speed or Trip Meter / Accel.	●	
Engine Coolant Temperature Gauge	●	
Max Power	●	
Low Speed / High Speed	●	
Auto Idle	●	
Overload warning with alarm	●	
Check Engine	●	
Air Cleaner Clogging	●	
Indicators	●	
ECO Gauges	●	
Fuel Level Gauge	●	
Hyd. Oil Temperature Gauge	●	
Fuel Warmer	●	
Warnings	●	
Communication Error	●	
Low Battery	●	
Clock	●	
Cabin Lights	●	
Cabin Front Window Rain Guard	●	
Cabin Roof-Steel Cover		●
Adjustable Air Suspension Seat With Heater	●	
FOG (Falling Object Protective Structure) - ISO 10262 Level 2	●	
ROPS (Roll Over Protective Structures) - ISO 12117-2	●	

SAFETY	STD	OPT
Lifting Mode	●	
Auto Safety Lock	●	
Seatbelt Warning Alarm	●	
Battery Master Switch	●	
Rear View Camera	●	
Rear & Mirror View Camera		●
AAVM (Advanced Around View Monitoring)		●
Four Front Working Lights (2 Boom Mounted, 2 Front Frame Mounted)	●	
Travel Alarm	●	
Rear Work Lamp		●
Beacon Lamp		●
Automatic Swing Brake	●	
Boom Holding System	●	
Arm Holding System	●	
Safety Lock Valve For Boom Cylinder With Overload Warning Device	●	
Safety Lock Valve For Arm Cylinder	●	
Safety Valve For Dozer Blade Cylinder	●	
Swing Lock System		●
Three Outside Rearview Mirror	●	
Front Guard - Wire Net		●
Guardrail - Boxing Ring		●

ATTACHMENT	STD	OPT
<b>Booms</b>		
4.1 m Mono		●
4.6 m Mono	●	
4.9 m 2-Piece		●
<b>Arms</b>		
1.9 m		●
2.1 m		●
2.5 m	●	
3.0 m		●

OTHER	STD	OPT
Fuel Pre-Filter	●	
Fuel Warmer	●	
Pre-Cleaner		●
Coolant Heater		●
Self-Diagnostics System	●	
Hi MATE (Remote Management System)	●	
Batteries (2 × 12 V × 72 AH)	●	
Fuel Filter Pump (35 lpm)		●
Single-Acting Piping Kit		●
Double-Acting Piping Kit	●	
Proportional Auxiliary Hydraulic System		●
2 Way Proportional RCV & Pedal Control Selection		●
Rotating Piping Kit		●
Bucket Line Dividing Kit		●
Air Compressor		●
Quick Coupler Piping		●
Quick Coupler		●
One Pedal Straight Travel System		●
Accumulator For Lowering Work Equipment	●	
Pattern Change Valve (2 Patterns)		●
Fine (Cushion/Free) Swing Control		●
Tool Kit		●
Dozer Blade		●

UNDERCARRIAGE	STD	OPT
Lower Frame Under Cover	●	
<b>Track Shoes</b>		
Triple Grousers Shoes (500 mm)		●
Triple Grousers Shoes (600 mm)	●	
Triple Grousers Shoe (700 mm)		●
Triple Grousers Shoe (700 mm) - H/W		●
Triple Grousers Shoe (800 mm) - H/W		●
Triple Grousers Shoe (900 mm) - H/W Mud Application		●
Track Guard	●	
Full Track Guard - H/W		●

\* Standard and optional equipment may vary. Contact your Hyundai dealer for more information. The machine may vary according to International standards.  
 \* The photos may include attachments and optional equipment that are not available in your area.  
 \* Materials and specifications are subject to change without advance notice.



# HYUNDAI

Specifications and design are subject to change without notice. Pictures of Hyundai Construction Equipment Europe products may show other than standard equipment.

Hyundai Construction Equipment Europe nv.  
Hyundailaan 4, 3980 Tessenderlo, Belgium.  
Tel: (32) 14-56-2200 Fax: (32) 14-59-3405

**READY TO CHANGE YOUR WORLD?**

Contact your Hyundai dealer.  
[hyundai-ce.eu/en/dealer-locator](https://hyundai-ce.eu/en/dealer-locator)