

CRAWLER EXCAVATOR

HX260AL



READY TO CHANGE YOUR WORLD

The HX260AL Crawler Excavator is part of Hyundai's new A-series:

a fresh generation of construction equipment that complies with the European stage V emission levels. But it goes much further than that! While fulfilling regulatory demands, Hyundai aimed for a ground-breaking level of customer satisfaction with maximum performance and productivity, better safety, more convenience and improved uptime management.

With a robust exterior design and smart performance-enhancing technologies, these hard-working machines open up a world of new possibilities where tiny efforts move mountains. It's time to experience the Hyundai Effect!



Productivity & Efficiency

POWERFUL AND FUEL-EFFICIENT TO BOOST PRODUCTIVITY

The HX260AL features the new A-series upper frame design, which boosts lifting capacity by up to 10%. Combined with the new lifting mode, this makes the HX260A the ideal machine for moving heavy objects around on the worksite.

A range of smart technologies are included for precise management of the engine output and pump flow rate. Additional control and monitoring features help you to further improve productivity every single day.

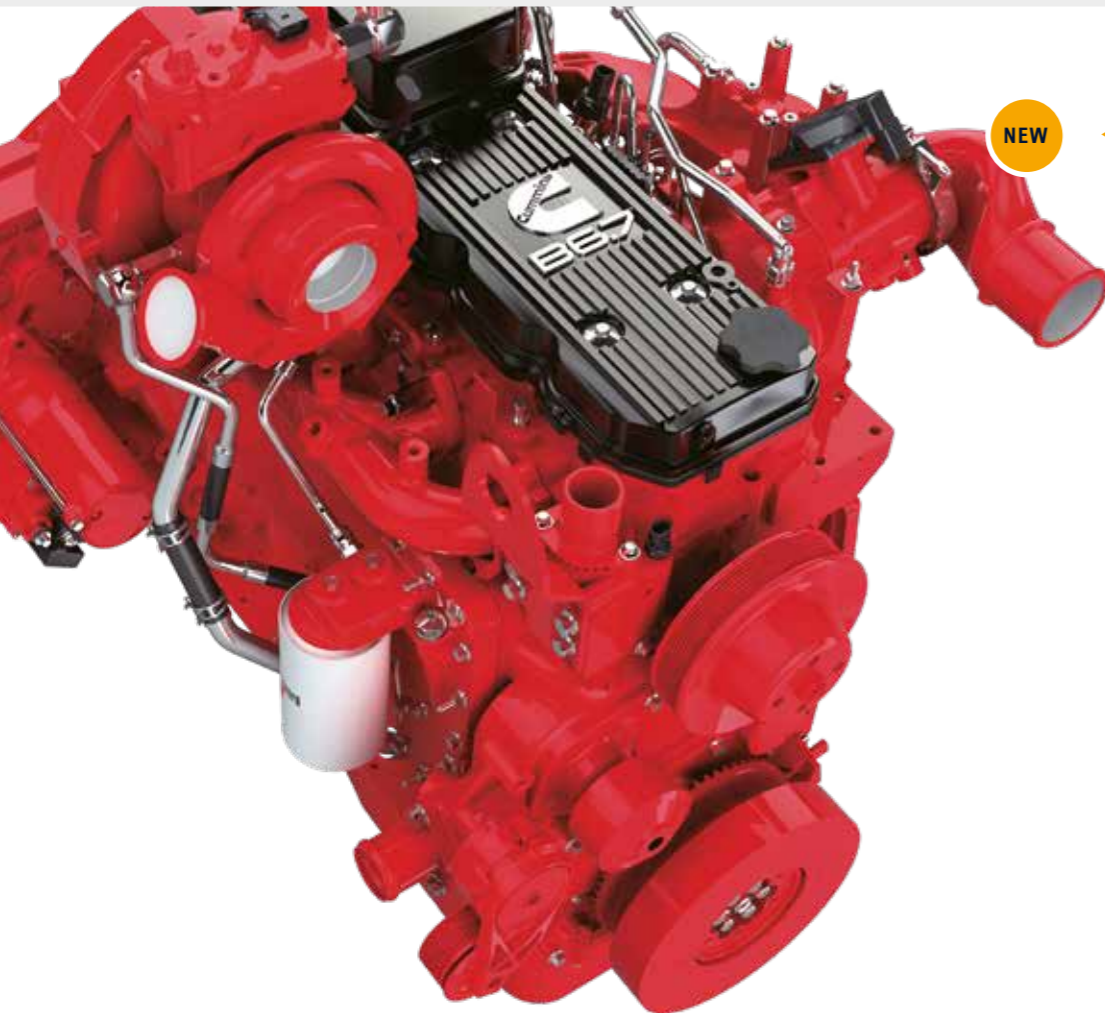

NEW

Engine

The HX260AL is equipped with an eco-friendly Cummins B6.7 engine that satisfies the strictest emissions requirements. It also delivers impressive power and performance with 949 Nm of peak torque (31% more than its predecessor) setting a new industry benchmark. Like all A-Series machines, this excavator features our all-in-one exhaust aftertreatment system. Removing the need for EGR has also enabled us to improve productivity through better fuel economy and longer service intervals.

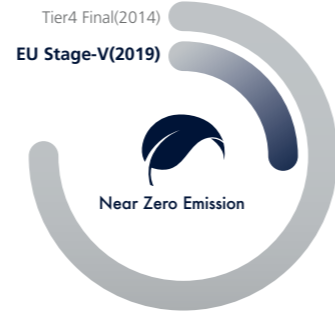

“The smart control technologies are easy to use and save me time and money on every job.”



Automatic engine shutdown

The engine shuts down automatically when the machine is at rest to cut fuel consumption and emissions. Different operating modes and idling times can be selected according to the work environment, further enhancing efficiency.

Eco Gauge

This feature helps operators to reduce emissions and running costs by displaying the engine workload and fuel-saving status.



NEW

Lifting mode

This work mode improves precision and lift capability through RPM reduction, power boost activation and enhanced pump flow control.

Fuel rate information

Average and latest fuel consumption data is displayed to guide operators towards more economical operation.



NEW

EPFC (Electronic Pump Flow Control)

EPFC improves fine control while also reducing fuel consumption. The system allows operators to tailor their machine for the job at hand, ensuring the optimal balance of power and precision.

Eco Report

The Eco Report feature makes it easy for operators to develop efficient working habits by displaying real-time information about machine performance.

NEW

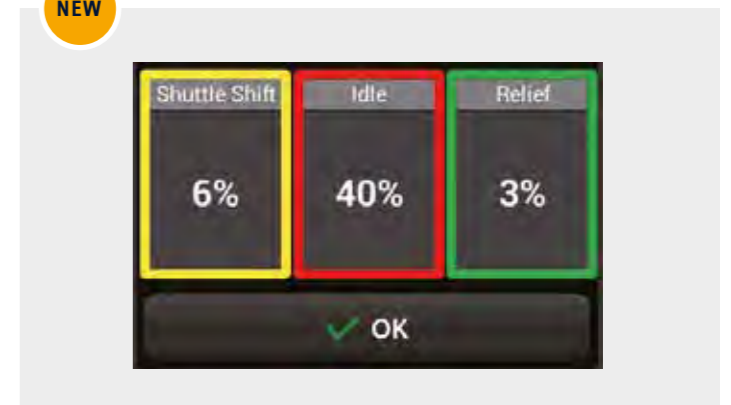

Durability

READY FOR ACTION AND BUILT TO LAST

You need to know that the investment you make today will help to sustain your business over the long term. That's why we prioritised reliability throughout the development of the HX260AL, from design and manufacturing to quality control. We improved engine reliability by removing the EGR and integrating exhaust after treatment with a simplified, single-module system that's easier to maintain. The upper and lower frame structures are reinforced for high load work, while the attachments have been rigorously tested for the roughest conditions. The overall aim is to minimise downtime and repairs so that you can stay on schedule, avoid unexpected costs and protect your profits.



“The HX260AL is robust, dependable and always ready for the next challenge!”

Bucket and attachments

As well as rigorously testing and reinforcing all attachments for durability, we have improved the wear resistance of the bucket by using a new material.



Cooling module

HX A-Series machines are enhanced with a durable cooling module that has been stringently tested to protect productivity in tough working environments.



Cabin structure

The cabin structure is reinforced with integrally welded, low-stress, high-strength steel. It is certified to ISO 12117-2 (ROPS - Roll-over Protective Structures) and ISO 10262 Level 2 (FOPS - Falling Object Protective Structures) safety standards.

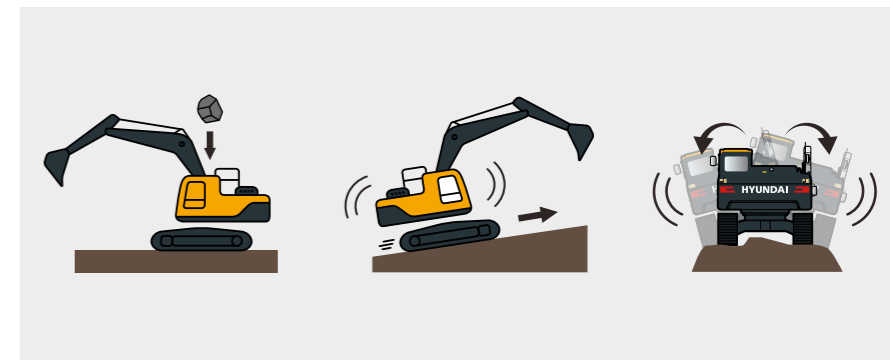

Side protectors

The machine can optionally be equipped with side bumpers to absorb any impact on the exterior frame and protect the machine.



OPTION

Operator Comfort

A CABIN DESIGNED AROUND YOU

The cabin is designed to provide every operator with a comfortable working environment that boosts productivity and reduces fatigue. It includes a high-quality seat and a well thought-out layout that places the most important controls within easy reach. A range of options help you to tailor the cabin to your needs, including an integrated audio system with radio, USB and AUX input to keep you entertained during your working day. The overall design places you right at the centre of the Hyundai Effect, with a world of convenience at your fingertips.



NEW

Key On Init Work Mode

This feature allows operators to save the attachment mode setting so that the machine is automatically in the right work mode when re-starting.

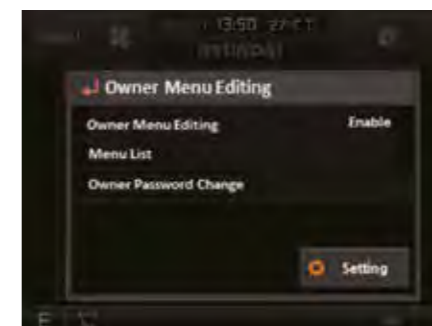

Owner Menu Editing (OME)

Menu functions can be set by the machine owner, who can also provide or restrict access for machine users by using a password to lock or unlock the list.



Combination speed setting system

This system allows operators to balance load sensitivity and boom priority against arm and swing. Select from five levels of load sensitivity to adjust initial flow rate for boom-up and arm-in operation according to attachment weight. Ten levels of boom priority can be selected to balance boom operation against arm and swing.



Wide touchscreen monitor

The HX260AL features an 8-inch display with a touchscreen and excellent legibility. All the indicators displaying machine status are centralised in one cluster to enable easy, efficient control.



NEW

Improved visibility and access

The open design of the cabin door gives the operator a clear, unimpeded view to the exterior. The door handle has also been redesigned for safer, more convenient access. The right-hand side of the machine also features a new design that gives the operator a better view of the bottom right side of the excavator.



OPTION

Straight travel pedal

The straight travel pedal option adds to comfort and convenience when travelling long distances or combining travel and attachment operation.

Proportional auxiliary hydraulic control

The optional proportional control system can be operated using sliders on the joystick, offering the operator more efficient and convenient control over the speed of work tools, especially in jobs requiring high precision or full-speed operation. Alternatively, control of the system can be switched over to a foot pedal via the settings menu.

OPTION

Fine swing control

Fine cushion swing control enables smooth movement at the beginning and end of swing operations. Fine free swing control reduces shaking of the weight during lifting.

OPTION



Jog dial module

For added convenience, the accelerator, remote air conditioner controller and instrument cluster can be operated using the integrated jog dial module.



Miracast connectivity

The Miracast system based on the operator's smartphone Wi-Fi allows the use of various smartphone features on the screen, including navigation, web surfing and music and video playback.

Safety

PROTECTION FOR YOUR CO-WORKERS AND EQUIPMENT

Small details can make a huge difference when it comes to safety and security. The HX260AL offers all-round protection for you, your workmates and your machinery. The cabin allows optimal visibility, while optional Advanced Around View Monitoring (AAVM) gives you a clear overview of your surroundings. By helping to ensure an accident-free worksite, these compact excavators contribute to the peace of mind and productivity that form part of the Hyundai Effect.



“New technologies have been added to protect machine operators and make the construction site a safer place.”



Seat belt warning alarm
Operators are reminded to fasten their safety belt by an audible and visible alarm.

Advanced Around View Monitoring (AAVM)
The AAVM camera system gives you a 360° overview of your immediate working environment. It also includes Intelligent Moving Object Detection (IMOD) technology that senses and warns you when people or objects come within five metres of the machine.

OPTION

Electronic swing parking system
The swing brake is controlled by an electronic valve and control system to improve safety and efficiency.

NEW

Auto safety lock
The auto safety lock feature prevents unintentional ignition. When the lock is activated, the excavator is not controlled by the RCV lever.

NEW

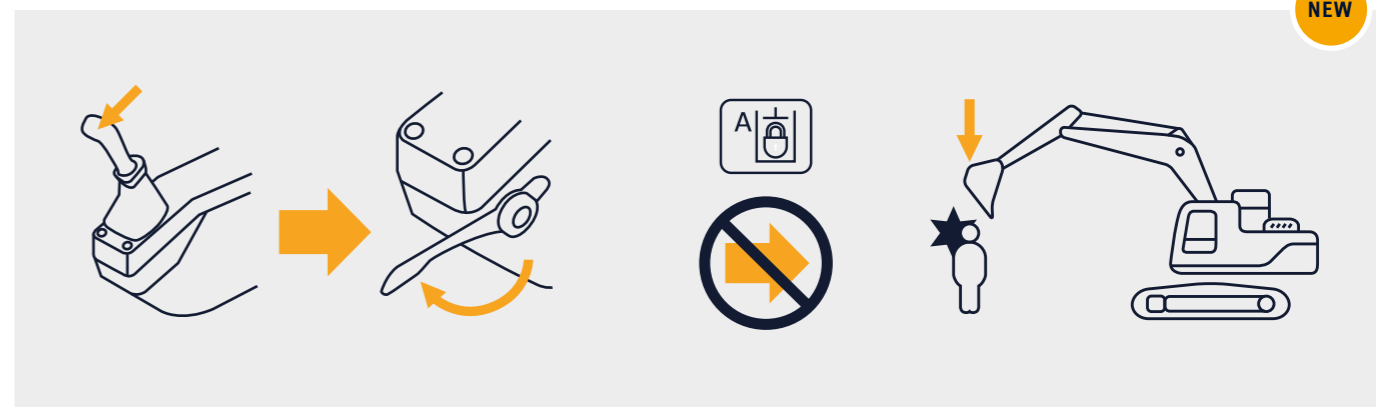

Serviceability & Connectivity

ADVANCED DIAGNOSTICS AND SERVICING SUPPORT

The peace of mind that comes with quick, low-effort servicing is also part of the Hyundai Effect. The HX260AL is designed to make maintenance as convenient as possible. All components and materials have been optimised to ensure a long, trouble-free life. Hyundai's innovative Hi MATE telematics system enables full monitoring of machine activity and performance. Maximum connectivity is integrated to help you create a smart construction site and protect your profitability.

"The new technologies make it easy to keep track of servicing tasks and get extra support if I need it."

HCE Diagnostic Tools (HCE-DT) app

Technicians can connect wirelessly to the machine on-site using a smartphone or laptop. A quick check can be performed to diagnose the root cause of a failure or to troubleshoot for fault codes. The HCE-DT app retrieves machine and engine data from a combined cloud-based platform to run a failure analysis in real-time. Combined with ECD, it increases first-visit fix rates.



Upgraded urea tank cover

The urea tank cover has been updated to a fully open type to make filling more convenient.



Mobile Fleet app

Hyundai's new Mobile Fleet app provides all the information you need to run your fleet efficiently and economically. Based on telematics, this advanced solution uses simple graphics and key performance data for smart fleet management.

200%
improved

Extended fuel filter lifetime

The fuel filter service interval has been increased from 500 hours to 1,000 hours. DPF cleaning is only required if alerted by a fault indication, eliminating the need for regular ash cleaning intervals.

HiMATE

Boost efficiency and performance

For maximum convenience and security, the HX260AL features Hyundai's exclusive Hi MATE remote fleet management system, which uses mobile data technology to provide the highest level of service and support. You can monitor your equipment wherever you are via a dedicated website or mobile app, with access to working parameters like total engine hours, machine utilisation, actual performed working hours and fuel consumption and machine location.



ECD (Engine Connected Diagnostics)

ECD provides troubleshooting advice as well as tailored servicing and parts support from Cummins Quick Serve. Service technicians are supported with remote diagnostics reports allowing them to prepare for site visits and bring the right tools.

We're all connected!



Just 5 minutes

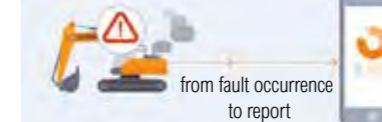

One-stop solution



Increase productivity

By providing information such as service hours, idle time and fuel consumption, Hi MATE saves you money and improves productivity. Service alerts enable better maintenance planning.



Monitor your machines

Hi MATE's real-time location information allows better, more convenient monitoring of your equipment. Just log onto the Hi MATE website or mobile app to see your machines at any time, from any location. Receive data online, by e-mail or directly on your mobile device.



Improve security

Protect your equipment from theft or unauthorised usage. Hi MATE's geofencing alerts notify you automatically when a machine leaves a predetermined zone.

Parts & Warranties

HYUNDAI GENUINE PARTS AND WARRANTIES: THE BEST WAY TO PROTECT YOUR INVESTMENT

Hyundai Genuine parts, accessories and warranty programmes are specially designed to keep your machine covered. They increase uptime and maintain the performance, comfort, and convenience that are built into your equipment.



A network you can rely on

Hyundai Construction Equipment Europe prioritises quick, reliable intervention to keep your equipment running reliably. In the 13000 m² warehouse, Hyundai covers over 96% of all Genuine Parts. With one of Europe's most advanced automated warehousing systems, we are able to maintain availability and efficient delivery of all our Genuine Parts. Moreover, we guarantee a 24-hour delivery service across our European dealer network.



Fuel filters

Hyundai fuel filters provide the right degree of filtration to keep your engine clean. They are designed to meet and exceed the engine manufacturer's prerequisites for water separation and dirt filtration, prolonging the life of your engine.



Hyundai Genuine parts

Hyundai Genuine parts have the same design as those installed when your machine left the factory. They are subjected to rigorous quality inspections and tests to make sure they meet Hyundai's strict requirements for quality and durability. As well as minimising downtime, this helps to ensure peak performance on every task.



Aftermarket kits

You can order Hyundai aftermarket kits via your dealer. This AAVM system for example, improves safety in and around your working environment at all times.



Hyundai warranties

Our warranties are also designed to give you the cover you need to build your business with confidence and peace of mind.

Standard warranties

We offer standard warranty coverages for all wheel loaders. Next to this standard coverage, optional and extended warranty periods are available, so you can benefit from full warranty coverage for longer, and even over the full lifetime of the machines. Please discuss the optimal solution for your needs with your local Hyundai dealer.

Extended warranties

Our extended warranties help you maintain full control over your operating costs. If you combine an extended warranty programme with a tailored maintenance contract, you can completely avoid unexpected costs.

Walk-around

HX260AL

Productivity & Efficiency

- High-performance, EGR-free engine (best-in-class) **NEW**
- Eco Report **NEW**
- Electronic Pump Flow Control (EPFC) **NEW**
- Lifting mode **NEW**
- Fuel Rate Information
- Eco Gauge
- Automatic engine shutdown

Serviceability

- Engine Connected Diagnostics (ECD) **NEW**
- Hi MATE telematics system
- 2x longer-lasting fuel filter (1,000 hrs)
- Upgraded urea tank cover
- Mobile Fleet app
- Connected diagnostics

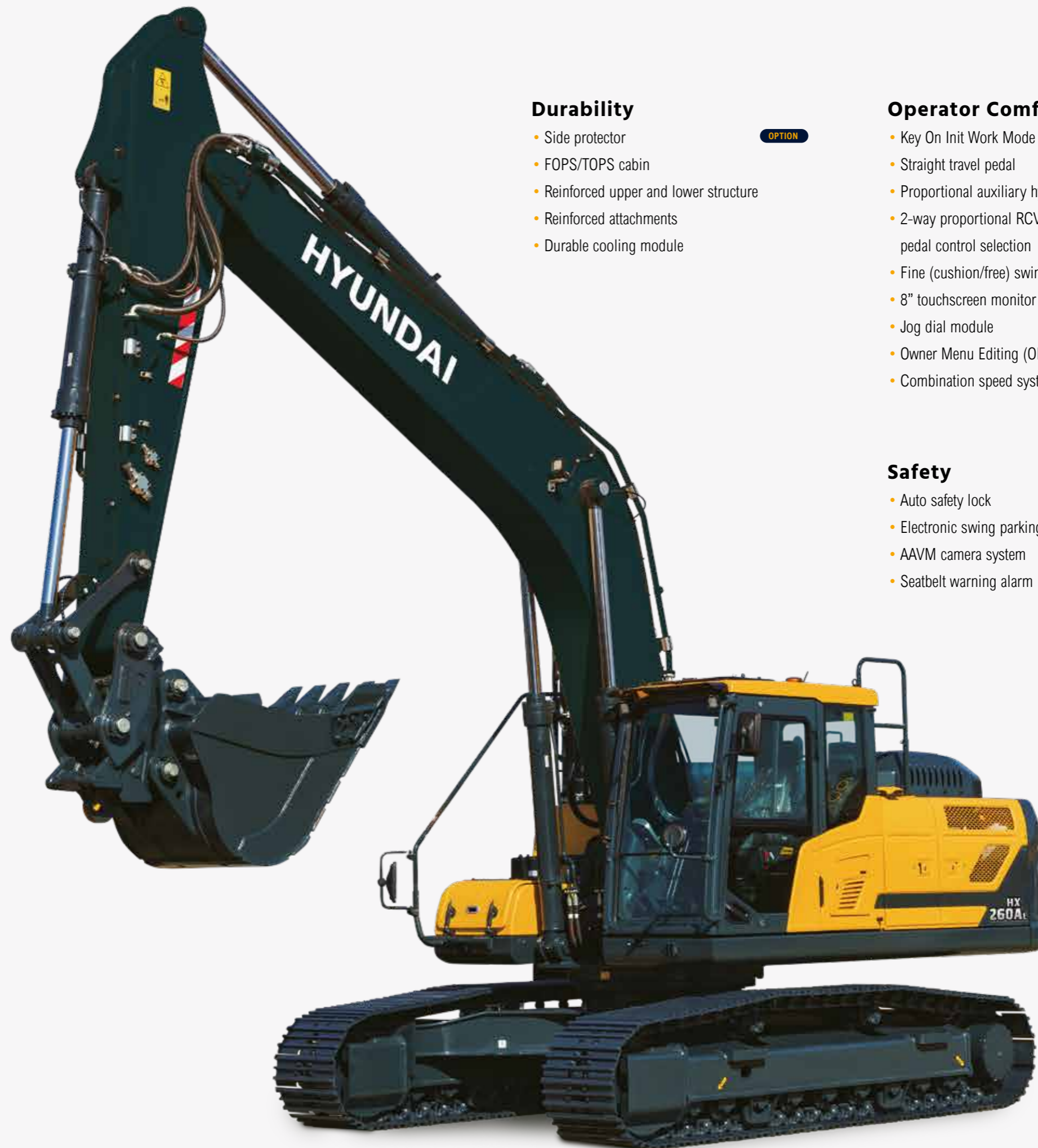

Durability

- Side protector **OPTION**
- FOPS/TOPS cabin
- Reinforced upper and lower structure
- Reinforced attachments
- Durable cooling module

Operator Comfort

- Key On Init Work Mode **NEW**
- Straight travel pedal **OPTION**
- Proportional auxiliary hydraulic system **OPTION**
- 2-way proportional RCV & pedal control selection **OPTION**
- Fine (cushion/free) swing Control **OPTION**
- 8" touchscreen monitor
- Jog dial module
- Owner Menu Editing (OME)
- Combination speed system

Safety

- Auto safety lock **NEW**
- Electronic swing parking brake **NEW**
- AAVM camera system **OPTION**
- Seatbelt warning alarm

READY TO CHANGE YOUR WORLD

Hyundai's crawler excavators are designed to create better conditions for operators and deliver the ultimate ownership experience. Every detail is carefully fine-tuned to match your needs in the field, including better safety and comfort, higher productivity, maximum uptime and easy servicing. It's all part of the Hyundai Effect.

Explore the range at hyundai-ce.eu

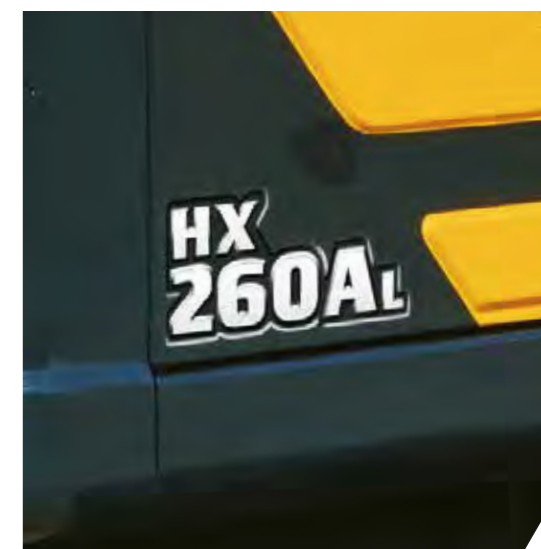

SPECIFICATIONS

ENGINE	
Maker / Model	CUMMINS / B6.7
Type	4 cylinder, Watercooled, 4-cycle, Turbocharged Charge Aircooled, Direct Injection, Electronic Controlled Diesel Engine
Gross Power	173kW (232 hp) at 2,000 rpm
Net Power	169kW (227 hp) at 2,000 rpm
Max. Power	173kW (232 hp) at 2,000 rpm
Peak Torque	949 N·m (700 lb·ft) at 1,500 rpm
Displacement	6.7 l (408 cu in)

HYDRAULIC SYSTEM	
MAIN PUMP	
Type	Variable Displacement Tandem Axis Piston Pumps
Max. Flow	2 x 221 l/min
Sub-Pump For Pilot Circuit	Gear pump

Cross-sensing and fuel saving pump system.

HYDRAULIC MOTORS	
Travel	Two Speed Axial Pistons Motor with Brake Valve and Parking Brake
Swing	Axial Piston Motor with Automatic Brake
RELIEF VALVE SETTING	
Implement Circuits	350 kgf/cm ² (4,980 psi)
Travel	350 kgf/cm ² (4,980 psi)
Power Boost (Boom, Arm, Bucket)	380 kgf/cm ² (5,400 psi)
Swing Circuit	300 kgf/cm ² (4,267 psi)
Pilot Circuit	40 kgf/cm ² (570 psi)
Service Valve	Installed

HYDRAULIC CYLINDERS	
Boom Cylinder	Ø135×1,395 mm
Arm Cylinder	Ø145×1,620 mm
Arm Cylinder (2-piece boom)	Ø145×1,620 mm
Adjust Cylinder (2-piece boom)	Ø160×1,230 mm
Bucket Cylinder	Ø130×1,185 mm

* Hyundai Bio Hydraulic Oil (HBHO) available.

DRIVING AND BRAKING	
Drive Method	Fully Hydrostatic Type
Drive Motor	Axial Piston Motor, In-Shoe Design
Reduction System	Planetary Reduction Gear
Max. Drawbar Pull	22,190 kgf (48,930 lbf)
Max. Travel Speed (High / Low)	5.6 km/hr (3.5 mph) / 3.3 km/hr (2.0 mph)
Gradeability	35° (70%)
Parking Brake	Multi Wet Disc

CONTROL	
Pilot pressure operated joysticks and pedals with detachable lever provide almost effortless and fatigueless operation.	
Pilot Control	Two Joysticks with One Safety Lever (LH): Swing and Arm (RH): Boom and Bucket
Traveling And Steering	Two Levers with Pedals
Engine Throttle	Electric, Dial Type

SWING SYSTEM	
Swing Motor	Fixed Displacement Axial Piston Motor
Swing Reduction	Planetary Gear Reduction
Swing Bearing Lubrication	Grease-Bathed
Swing Brake	Multi Wet Disc
Swing Speed	11.2 rpm

CAPACITIES			
	liter	US gal	UK gal
Fuel Tank	450	119	99
Engine Coolant	40	10.6	8.8
Engine Oil	23.1	6.1	5.1
Swing Device	6.2	1.64	1.36
Final Drive (Each)	4.5	1.2	1
Hydraulic System (Including Tank)	275	72.6	60.5
Hydraulic Tank	155	40.1	34.1
DEF/AdBlue®	27	7.1	5.9

UNDERCARRIAGE	
The X-leg type center frame is integrally welded with reinforced box-section track frames. The undercarriage includes lubricated rollers, idlers, track adjusters with shock absorbing springs and sprockets, and a track chain with double or triple grouser shoes.	
Center frame	X - leg type
Track frame	Pentagonal box type
Number of Shoes on each side	51 EA
Number of Carrier Rollers on each side	2 EA
Number of Track Rollers on each side	9 EA
Number of Rail Guards on each side	2 EA

OPERATING WEIGHT (APPROXIMATE)	
Operating weight, including 5.85m (19' 2") boom, 3.05m (10' 0") arm, SAE heaped 1.08 m ³ (1.40 yd ³) bucket, lubricant, coolant, full fuel tank, full hydraulic tank, and all standard equipments.	

OPERATING WEIGHT			
Shoes	Width mm (in)	Operating Weight kg (lb)	Ground Pressure kgf/cm ² (psi)
Triple Grouser	600 (24")	27,000 (59,520)	0.55 (7.81)
	700 (28")	27,310 (60,210)	0.48 (6.77)
	800 (32")	27,600 (60,850)	0.42 (5.99)
	900 (36")	27,910 (61,530)	0.38 (5.39)

AIR CONDITIONING SYSTEM	
The air condition system for the machine contains the fluorinated greenhouse gas with global warming potential of R134a. (Global Warming Potential : 1.430) The system hold 0.80 kg refrigerant consisting of a CO ₂ of 1.14 metric tonnes. For more information, please refer to the manual.	

DIMENSIONS & WORKING RANGE

HX260A L / HX260A NL MONO BOOM DIMENSIONS

5.85 m (19' 2") MONO BOOM and 3.05 m (10' 0"), 2.1 m (6' 11"), 2.5 m (8' 2"), 3.6 m (11' 10") ARM

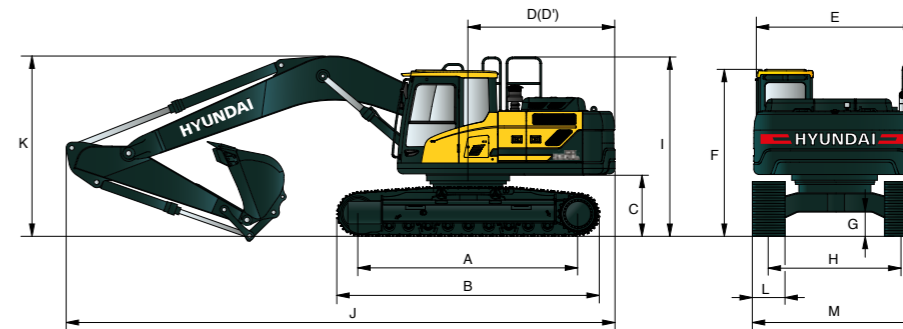

Unit : mm (ft-in)

A	Tumbler Distance	3,830 (12' 7")
B	Overall length of Crawler	4,640 (15' 3")
C	Ground Clearance of Counterweight	1,110 (3' 8")
D	Tail Swing Radius	3,085 (10' 1")
D'	Rear-End Length	2,990 (9' 10")
E	Overall Width of Upperstructure	2,840 (9' 4")
F	Overall Height of Cabin	3,050 (10' 0")
G	Min. Ground Clearance	480 (1' 7")
H	Track Gauge	HX260AL 2,580 (8' 6")
		HX260ANL 2,380 (7' 10")
I	Overall Height of Guardrail	3,260 (10' 8")

Boom Length		5,850 (19' 2")			
Arm Length		3,050 (10' 0")	2,100 (6' 11")	2,500 (8' 2")	3,600 (11' 10")
J	Overall Length	10,040 (32' 11")	10,170 (33' 4")	10,120 (33' 2")	10,030 (32' 11")
K	Overall Height of Boom	3,220 (10' 7")	3,530 (11' 7")	3,590 (11' 9")	3,590 (11' 9")
L	Track Shoe Width	TRIPLE GROUSER			
		600 (1' 12")	700 (2' 4")	800 (2' 7")	900 (2' 11")
M	Overall Width	HX260AL 3,180 (10' 5")	3,280 (10' 9")	3,380 (11' 1")	3,480 (11' 5")
		HX260ANL 2,980 (9' 9")	3,080 (10' 1")	3,180 (10' 5")	

* This figure includes the size of grousers.

HX260A L / HX260A NL MONO BOOM WORKING RANGE

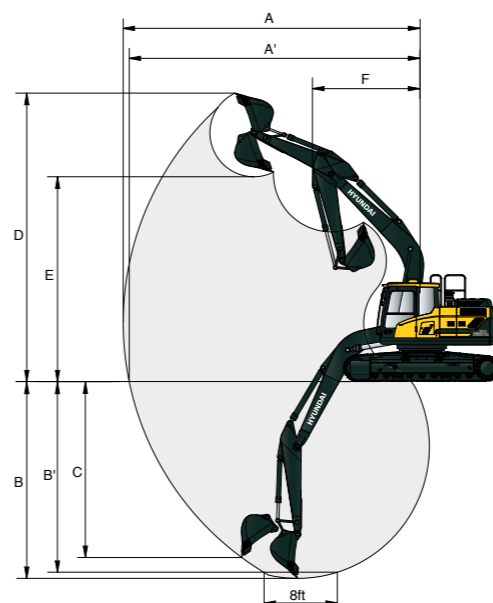

Unit : mm (ft-in)

Boom Length		5,850 (19' 2")			
Arm Length		3,050 (10' 0")	2,100 (6' 11")	2,500 (8' 2")	3,600 (11' 10")
A	Max. Digging Reach	10,360 (34' 0")	9,550 (31' 4")	9,870 (32' 5")	10,870 (35' 8")
A'	Max. Digging Reach on Ground	10,190 (33' 5")	9,360 (30' 9")	9,680 (31' 9")	10,700 (35' 1")
B	Max. Digging Depth	7,000 (23' 0")	6,050 (19' 10")	6,450 (21' 2")	7,550 (24' 9")
B'	Max. Digging Depth (8' level)	6,830 (22' 5")	5,840 (19' 2")	6,260 (20' 6")	7,400 (24' 3")
C	Max. Vertical Wall Digging Depth	6,150 (20' 2")	5,480 (18' 0")	5,640 (18' 6")	6,830 (22' 5")
D	Max. Digging Height	9,670 (31' 9")	9,450 (31' 0")	9,460 (31' 0")	9,920 (32' 7")
E	Max. Dumping Height	6,630 (21' 9")	6,360 (20' 10")	6,420 (21' 1")	6,860 (22' 6")
F	Min. Front Swing Radius	3,980 (13' 1")	4,420 (14' 6")	4,200 (13' 9")	3,900 (12' 10")

DIMENSIONS & WORKING RANGE

HX260A L / HX260ANL 2-PIECE BOOM DIMENSIONS

5.90 m (19' 4") 2-PIECE BOOM and 3.05 m (10' 0"), 2.1 m (6' 11"), 2.5 m (8' 2") ARM

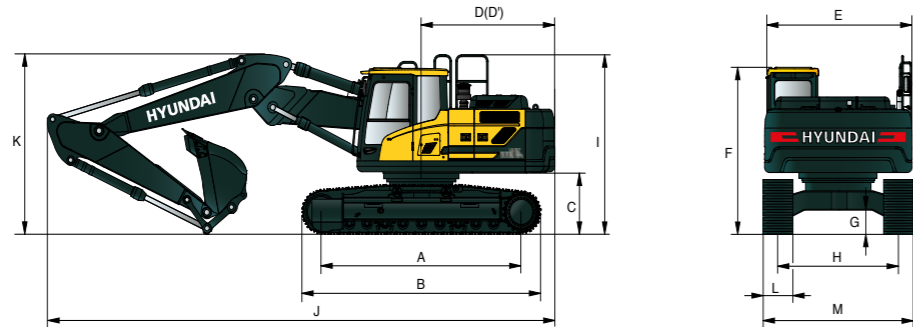

Unit : mm (ft-in)

A	Tumbler Distance	3,830 (12' 7")
B	Overall length of Crawler	4,640 (15' 3")
C	Ground Clearance of Counterweight	1,110 (3' 8")
D	Tail Swing Radius	3,085 (10' 1")
D'	Rear-End Length	2,990 (9' 10")
E	Overall Width of Upperstructure	2,840 (9' 4")
F	Overall Height of Cabin	3,050 (10' 0")
G	Min. Ground Clearance	480 (1' 7")
H	Track Gauge	HX260AL 2,580 (8' 6")
		HX260ANL 2,380 (7' 10")
I	Overall Height of Guardrail	3,260 (10' 8")

Boom Length		5,90 (19' 4")			
Arm Length		3,050 (10' 0")	2,100 (6' 11")	2,500 (8' 2")	3,600 (11' 10")
J	Overall Length	10,040 (32' 11")	10,170 (33' 4")	10,120 (33' 2")	10,030 (32' 11")
K	Overall Height of Boom	3,220 (10' 7")	3,530 (11' 7")	3,590 (11' 9")	3,590 (11' 9")
L	Track Shoe Width	TRIPLE GROUSER			
		600 (1' 12")	700 (2' 4")	800 (2' 7")	900 (2' 11")
M	Overall Width	HX260AL 3,180 (10' 5")	3,280 (10' 9")	3,380 (11' 1")	3,480 (11' 5")
		HX260ANL 2,980 (9' 9")	3,080 (10' 1")	3,180 (10' 5")	

* This figure includes the size of grouser.

HX260A L / HX260ANL 2-PIECE BOOM WORKING RANGE

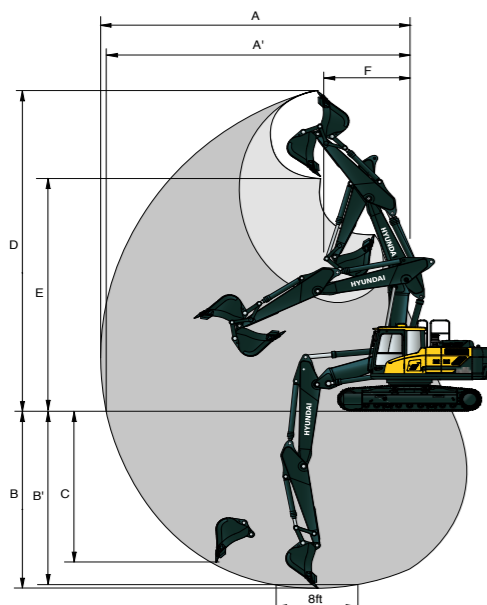

Unit : mm (ft-in)

Boom Length		5,90 (19' 4")			
Arm Length		3,050 (10' 0")	2,100 (6' 11")	2,500 (8' 2")	3,600 (11' 10")
A	Max. Digging Reach	10,360 (34' 0")	9,550 (31' 4")	9,870 (32' 5")	10,870 (35' 8")
A'	Max. Digging Reach on Ground	10,190 (33' 5")	9,360 (30' 9")	9,680 (31' 9")	10,700 (35' 1")
B	Max. Digging Depth	7,000 (23' 0")	6,050 (19' 10")	6,450 (21' 2")	7,550 (24' 9")
B'	Max. Digging Depth (8' level)	6,830 (22' 5")	5,840 (19' 2")	6,260 (20' 6")	7,400 (24' 3")
C	Max. Vertical Wall Digging Depth	6,150 (20' 2")	5,480 (18' 0")	5,640 (18' 6")	6,830 (22' 5")
D	Max. Digging Height	9,670 (31' 9")	9,450 (31' 0")	9,460 (31' 0")	9,920 (32' 7")
E	Max. Dumping Height	6,630 (21' 9")	6,360 (20' 10")	6,420 (21' 1")	6,860 (22' 6")
F	Min. Front Swing Radius	3,980 (13' 1")	4,420 (14' 6")	4,200 (13' 9")	3,900 (12' 10")

LIFTING CAPACITY

Rating over-front Rating over-side or 360 degrees

HX260A L MONO BOOM

Boom 5.85 m (19' 2") / Arm 2.1 m (6' 11") / CWT 4,600 kg / Shoe 600 mm (24") triple grouser



Lift-point height m (ft)	Lift-point radius								At max. Reach		
	3.0 m (9.8 ft)		4.5 m (14.8 ft)		6.0 m (19.7 ft)		7.5 m (24.6 ft)		Capacity	Reach	
7.5 m (24.6 ft)	kg								*7,270	*7,270	5.55
	lb								*16,030	*16,030	(18.2)
6.0 m (19.7 ft)	kg		*7,460	*7,460	*7,010	6,810			*7,100	5,540	6.77
	lb		*16,450	*16,450	*15,450	15,010			*15,650	12,210	(22.2)
4.5 m (14.8 ft)	kg		*9,290	*9,290	*7,660	6,580			6,940	4,610	7.49
	lb		*20,480	*20,480	*16,890	14,510			15,300	10,160	(24.6)
3.0 m (9.8 ft)	kg				*8,710	6,260	6,810	4,490	6,320	4,170	7.86
	lb				*19,200	13,800	15,010	9,900	13,930	9,190	(25.8)
1.5 m (4.9 ft)	kg				9,330	5,970	6,670	4,360	6,140	4,030	7.93
	lb				20,570	13,160	14,700	9,610	13,540	8,880	(26.0)
Ground Line	kg		*14,080	8,760	9,150	5,810	6,590	4,290	6,340	4,140	7.70
	lb		*31,040	19,310	20,170	12,810	14,530	9,460	13,980	9,130	(25.3)
-1.5 m (-4.9 ft)	kg		*13,680	8,790	9,120	5,780			7,070	4,590	7.16
	lb		*30,160	19,380	20,110	12,740			15,590	10,120	(23.5)
-3.0 m (-9.8 ft)	kg	*16,680	*16,680	*12,330	8,960	*9,030	5,940		*8,540	5,700	6.20
	lb	*36,770	*36,770	*27,180	19,750	*19,910	13,100		*18,830	12,570	(20.4)
-4.5 m (-14.8 ft)	kg										
	lb										

Boom 5.85 m (19' 2") / Arm 2.5 m (8' 2") / CWT 4,600 kg / Shoe 600 mm (24") triple grouser

Lift-point height m (ft)	Lift-point radius								At max. Reach			
	3.0 m (9.8 ft)		4.5 m (14.8 ft)		6.0 m (19.7 ft)		7.5 m (24.6 ft)		Capacity	Reach		
7.5 m (24.6 ft)	kg								*6,080	*6,080	6.00	
	lb								*13,400	*13,400	(19.7)	
6.0 m (19.7 ft)	kg				*6,490	*6,490			*5,660	5,130	7.14	
	lb				*14,310	*14,310			*12,480	11,310	(23.4)	
4.5 m (14.8 ft)	kg		*8,570	*8,570	*7,220	6,650	*6,700	4,650	*5,580	4,320	7.82	
	lb		*18,890	*18,890	*15,920	14,660	*14,770	10,250	*12,300	9,520	(25.7)	
3.0 m (9.8 ft)	kg		*11,080	9,640	*8,340	6,310	6,840	4,510	*5,740	3,930	8.18	
	lb		*24,430	21,250	*18,390	13,910	15,080	9,940	*12,650	8,660	(26.8)	
1.5 m (4.9 ft)	kg		*13,120	9,020	9,370	6,000	6,670	4,360	5,780	3,790	8.25	
	lb		*28,920	19,890	20,660	13,230	14,700	9,610	12,740	8,360	(27.1)	
Ground Line	kg		*13,980	8,760	9,150	5,800	6,560	4,260	5,950	3,880	8.03	
	lb		*30,820	19,310	20,170	12,790	14,460	9,390	13,120	8,550	(26.3)	
-1.5 m (-4.9 ft)	kg	*11,520	*11,520	*13,860	8,730	9,080	5,740	6,550	4,260	6,540	4,250	7.51
	lb	*25,400	*25,400	*30,560	19,250	20,020	12,650	14,440	9,390	14,420	9,370	(24.6)
-3.0 m (-9.8 ft)	kg	*17,870	17,830	*12,810	8,860	9,180	5,830		7,980	5,140	6.61	
	lb	*39,400	39,310	*28,240	19,530	20,240	12,850		17,590	11,330	(21.7)	
-4.5 m (-14.8 ft)	kg			*10,080	9,220				*8,510	7,660	5.12	
	lb			*22,220	20,330				*18,760	16,890	(16.8)	











- Lifting capacity is based on ISO 10567.
- Lifting capacity of HX Series does not exceed 75% of tipping load with the machine on firm, level ground or 87% of full hydraulic capacity.
- The Lift-point is bucket pivot mounting pin on the arm (without bucket mass).
- (*) indicates load limited by hydraulic capacity.

LIFTING CAPACITY











 Rating over-front  Rating over-side or 360 degrees

HX260A NL MONO BOOM

Boom 5.85 m (19' 4") / Arm 2.1 m (6' 11") / CWT 6,100 kg / Shoe 600 mm (24") triple grouser



Lift-point height m (ft)	kg lb	Lift-point radius								At max. Reach		
		3.0 m (9.8 ft)		4.5 m (14.8 ft)		6.0 m (19.7 ft)		7.5 m (24.6 ft)		Capacity	Reach	
												m (ft)
7.5 m (24.6 ft)	kg lb									*7,280 *16,050	*7,280 *16,050	5.50 (18.1)
6.0 m (19.7 ft)	kg lb			*7,430 *16,380	*7,430 *16,380	*7,000 *15,430	6,570 14,480			*7,110 *15,670	5,390 11,880	6.74 (22.1)
4.5 m (14.8 ft)	kg lb			*9,220 *20,330	*9,220 *20,330	*7,630 *16,820	6,350 14,000			*7,160 *15,790	4,470 9,850	7.47 (24.5)
3.0 m (9.8 ft)	kg lb					*8,680 *19,140	6,030 13,290	7,100 15,650	4,350 9,590	6,600 14,550	4,040 8,910	7.85 (25.8)
1.5 m (4.9 ft)	kg lb					*9,680 *21,340	5,750 12,680	6,960 15,340	4,220 9,300	6,400 14,110	3,910 8,580	7.93 (26.0)
Ground Line	kg lb			*14,080 *31,040	8,340 18,390	9,540 21,030	5,590 12,320	6,870 15,150	4,140 9,130	6,610 14,570	3,990 8,900	7.72 (25.3)
-1.5 m (-4.9 ft)	kg lb			*13,700 *30,200	8,360 18,430	9,510 20,970	5,560 12,260			7,340 16,180	4,410 9,720	7.18 (23.6)
-3.0 m (-9.8 ft)	kg lb	*16,760 *36,950	16,720 36,860	*12,390 *27,320	8,530 18,810	*9,090 *20,040	5,700 12,570			*8,530 *18,810	5,440 11,990	6.24 (20.5)
-4.5 m (-14.8 ft)	kg lb											

Boom 5.85 m (19' 2") / Arm 2.5 m (8' 2") / CWT 6,100 kg / Shoe 600 mm (24") triple grouser

Lift-point height m (ft)	kg lb	Lift-point radius								At max. Reach		
		3.0 m (9.8 ft)		4.5 m (14.8 ft)		6.0 m (19.7 ft)		7.5 m (24.6 ft)		Capacity	Reach	
												m (ft)
7.5 m (24.6 ft)	kg lb									*6,100 *13,450	*6,100 *13,450	5.96 (19.5)
6.0 m (19.7 ft)	kg lb					*6,480 *14,290	*6,480 *14,290			*5,660 *12,480	4,990 11,000	7.11 (23.3)
4.5 m (14.8 ft)	kg lb			*8,510 *18,760	*8,510 *18,760	*7,190 *15,850	6,420 14,150	*6,690 *14,750	4,500 9,920	*5,580 *12,300	4,200 9,260	7.81 (25.6)
3.0 m (9.8 ft)	kg lb			*11,010 24,270	9,210 20,300	*8,300 *18,300	6,080 13,400	7,130 15,720	4,370 9,630	*5,730 *12,630	3,810 8,400	8.17 (26.8)
1.5 m (4.9 ft)	kg lb			*13,080 *28,840	8,600 18,960	*9,400 *20,720	5,780 12,740	6,960 15,340	4,220 9,300	6,030 13,290	3,670 8,090	8.25 (27.1)
Ground Line	kg lb			*13,970 *30,800	8,330 18,360	9,540 21,030	5,580 12,300	6,850 15,100	4,110 9,060	6,200 13,670	3,740 8,250	8.04 (26.4)
-1.5 m (-4.9 ft)	kg lb	*11,300 *24,910	*11,300 *24,910	*13,880 *30,600	8,300 18,300	9,470 20,880	5,520 12,170	6,840 15,080	4,110 9,060	6,800 14,990	4,090 9,020	7.53 (24.7)
-3.0 m (-9.8 ft)	kg lb	*17,940 *39,550	16,500 36,380	*12,860 *28,350	8,430 18,580	*9,540 *21,030	5,600 12,350			8,260 18,210	4,920 4,920	6.64 (21.8)
-4.5 m (-14.8 ft)	kg lb	*14,190 *31,280	*14,190 *31,280	*10,200 *22,490	8,770 19,330					*8,510 *18,760	4,920 15,900	5.17 (17.0)











1. Lifting capacity is based on ISO 10567.
2. Lifting capacity of HX Series does not exceed 75% of tipping load with the machine on firm, level ground or 87% of full hydraulic capacity.
3. The Lift-point is bucket pivot mounting pin on the arm (without bucket mass).
4. (*) indicates load limited by hydraulic capacity.

LIFTING CAPACITY













 Rating over-front  Rating over-side or 360 degrees

HX260A NL MONO BOOM

Boom 5.85 m (19' 2") / Arm 3.05 m (10' 0") / CWT 6,100 kg / Shoe 600 mm (24") triple grouser

Lift-point height m (ft)	kg lb	Lift-point radius								At max. Reach			
		3.0 m (9.8 ft)		4.5 m (14.8 ft)		6.0 m (19.7 ft)		7.5 m (24.6 ft)		Capacity	Reach		
												m (ft)	
7.5 m (24.6 ft)	kg lb					*5,640 *12,430	*5,640 *12,430			*4,020 *8,860	*4,020 *8,860	6.62 (21.7)	
6.0 m (19.7 ft)	kg lb					*5,740 *12,650	*5,740 *12,650	*4,610 *10,160	*4,610 *10,160	*3,770 *8,310	*3,770 *8,310	7.68 (25.2)	
4.5 m (14.8 ft)	kg lb					*6,520 *14,370	6,490 14,310	*6,110 *13,470	4,530 9,990	*3,720 *8,200	*3,720 *8,200	8.33 (27.3)	
3.0 m (9.8 ft)	kg lb					*7,690 *16,950	6,140 13,540	*6,670 *14,700	4,370 9,630	*3,820 *8,420	3,450 7,610	8.67 (28.4)	
1.5 m (4.9 ft)	kg lb					*8,900 *19,620	5,790 12,760	6,940 15,300	4,190 9,240	*4,080 *8,990	3,320 7,320	8.74 (28.7)	
Ground Line	kg lb					*6,220 *13,710	*6,220 *13,710	9,510 20,970	5,540 12,210	6,790 14,970	4,050 8,930	*4,550 *10,030	3,370 7,430
-1.5 m (-4.9 ft)	kg lb	*7,030 *15,500	*7,030 *15,500	*11,040 *24,340	*11,040 *24,340	9,380 20,680	5,430 11,970	6,730 14,840	4,000 8,820	*5,370 *11,840	3,630 8,000	8.06 (26.5)	
-3.0 m (-9.8 ft)	kg lb	*11,970 *26,390	*11,970 *26,390	*17,380 *38,320	16,150 35,600	9,410 20,750	5,450 12,020			*6,990 *15,410	4,250 9,370	7.24 (23.8)	
-4.5 m (-14.8 ft)	kg lb			*16,090 *35,470	*16,090 *35,470					*8,150 *17,970	5,770 12,720	5.93 (19.5)	

Boom 5.85 m (19' 2") / Arm 3.6 m (11' 10") / CWT 6,100 kg / Shoe 600 mm (24") triple grouser

Lift-point height m (ft)	kg lb	Lift-point radius										At max. Reach					
		1.5 m (4.9 ft)		3.0 m (9.8 ft)		4.5 m (14.8 ft)		6.0 m (19.7 ft)		7.5 m (24.6 ft)		9.0 m (29.5 ft)		Capacity	Reach		
																m (ft)	
9.0 m (29.5 ft)	kg lb													*3,970 *8,750	*3,970 *8,750	5.78 (19.0)	
7.5 m (24.6 ft)	kg lb													*3,480 *7,670	*3,480 *7,670	7.28 (23.9)	
6.0 m (19.7 ft)	kg lb									*5,120 *11,290	4,700 10,360			*3,290 *7,250	*3,290 *7,250	8.25 (27.1)	
4.5 m (14.8 ft)	kg lb								*5,840 *12,870	*5,840 *12,870	*5,570 *12,280	4,580 10,100		*3,250 *7,170	*3,250 *7,170	8.86 (29.1)	
3.0 m (9.8 ft)	kg lb					*8,860 *19,530	*8,860 *19,530	*7,060 *15,560	6,210 13,690	*6,190 *13,650	4,390 9,680	*4,220 *9,300	3,240 7,140	*3,330 *7,340	3,130 6,900	9.18 (30.1)	
1.5 m (4.9 ft)	kg lb					*11,390 *25,110	8,820 19,440	*8,360 *18,430	5,820 12,830	*6,910 *15,230	4,190 9,240	*4,880 *10,760	3,150 6,940	*3,540 *7,800	3,010 6,640	9.25 (30.3)	
Ground Line	kg lb					*7,000 *15,430	*7,000 *15,430	*13,090 *28,860	8,300 18,300	*9,420 *20,770	5,520 12,170	6,760 14,900	4,020 8,860	*4,350 *9,590	3,070 6,770	*3,900 *8,600	3,040 6,700
-1.5 m (-4.9 ft)	kg lb	*6,330 *13,960	*6,330 *13,960	*10,390 *22,910	*10,390 *22,910	*13,760 *30,340	8,090 17,840	9,320 20,550	5,360 11,820	6,650 14,660	3,920 8,640			*4,520 *9,960	3,240 7,140	8.61 (28.3)	
-3.0 m (-9.8 ft)	kg lb	*10,310 *22,730	*10,310 *22,730	*15,300 *33,730	*15,300 *33,730	*13,520 *29,810	8,090 17,840	9,290 20,480	5,330 11,750	6,670 14,700	3,930 8,660			*5,670 *12,500	3,710 8,180	7.85 (25.8)	
-4.5 m (-14.8 ft)	kg lb	*15,330 *33,800	*15,330 *33,800	*17,610 *38,820	16,210 35,740	*12,190 *26,870	8,270 18,230	*8,910 *19,640	5,470 12,060					*7,630 *16,820	4,770 10,520	6.66 (21.9)	
-6.0 m (-19.7 ft)	kg lb																

1. Lifting capacity is based on ISO 10567.
2. Lifting capacity of HX Series does not exceed 75% of tipping load with the machine on firm, level ground or 87% of full hydraulic capacity.
3. The Lift-point is bucket pivot mounting pin on the arm (without bucket mass).
4. (*) indicates load limited by hydraulic capacity.

LIFTING CAPACITY

Rating over-front Rating over-side or 360 degrees

HX260A NL 2-PIECE BOOM

Boom 5.90 m (19' 4") / Arm 2.1 m (6' 11") / CWT 6,100 kg / Shoe 600 mm (24") triple grouser

Lift-point height m (ft)	Lift-point radius								At max. Reach		
	3.0 m (9.8 ft)		4.5 m (14.8 ft)		6.0 m (19.7 ft)		7.5 m (24.6 ft)		Capacity	Reach	
9.0m (29.5 ft)	kg								*11,550	*11,550	3.48 (11.4)
	lb								*25,460	*25,460	
7.5 m (24.6 ft)	kg		*8,710	*8,710					*7,680	*7,680	5.66 (18.6)
	lb		*19,200	*19,200					*16,930	*16,930	
6.0 m (19.7 ft)	kg		*9,080	*9,080	*7,110	*7,110			*6,500	5,680	6.87 (22.5)
	lb		*20,020	*20,020	*15,670	*15,670			*14,330	12,520	
4.5 m (14.8 ft)	kg		*10,770	10,640	*7,560	6,890	*6,040	4,850	*6,000	4,750	7.59 (24.9)
	lb		*23,740	23,460	*16,670	15,190	*13,320	10,690	*13,230	10,470	
3.0 m (9.8 ft)	kg				*8,450	6,550	*6,230	4,730	*5,850	4,310	7.96 (26.1)
	lb				*18,630	14,440	*13,730	10,430	*12,900	9,500	
1.5 m (4.9 ft)	kg				*9,540	6,240	*6,550	4,600	*5,970	4,170	8.04 (26.4)
	lb				*21,030	13,760	*14,440	10,140	*13,160	9,190	
Ground Line	kg				*9,920	6,080	*6,830	4,520	*6,380	4,280	7.83 (25.7)
	lb				*21,870	13,400	*15,060	9,960	*14,070	9,440	
-1.5 m (-4.9 ft)	kg		*11,200	9,120	*8,770	6,070			*6,390	4,730	7.3 (23.9)
	lb		*24,690	20,110	*19,330	13,380			*14,090	10,430	
-3.0 m (-9.8 ft)	kg				*6,170	*6,170					
	lb				*13,600	*13,600					

Boom 5.90 m (19' 4") / Arm 2.5 m (8' 2") / CWT 6,100 kg / Shoe 600 mm (24") triple grouser

Lift-point height m (ft)	Lift-point radius								At max. Reach			
	3.0 m (9.8 ft)		4.5 m (14.8 ft)		6.0 m (19.7 ft)		7.5 m (24.6 ft)		Capacity	Reach		
9.0m (29.5 ft)	kg								*7,590	*7,590	4.21 (13.8)	
	lb								*16,730	*16,730		
7.5 m (24.6 ft)	kg		*8,210	*8,210	*6,870	*6,870			*6,130	*6,130	6.13 (20.1)	
	lb		*18,100	*18,100	*15,150	*15,150			*13,510	*13,510		
6.0 m (19.7 ft)	kg		*8,580	*8,580	*6,770	*6,770			*5,640	5,250	7.25 (23.8)	
	lb		*18,920	*18,920	*14,930	*14,930			*12,430	11,570		
4.5 m (14.8 ft)	kg		*10,030	*10,030	*7,230	6,980	*5,740	4,910	*5,480	4,450	7.94 (26)	
	lb		*22,110	*22,110	*15,940	15,390	*12,650	10,820	*12,080	9,810		
3.0 m (9.8 ft)	kg		*13,030	9,970	*8,100	6,610	*6,000	4,760	*5,370	4,060	8.3 (27.2)	
	lb		*28,730	21,980	*17,860	14,570	*13,230	10,490	*11,840	8,950		
1.5 m (4.9 ft)	kg		*13,890	9,320	*9,210	6,280	*6,370	4,600	*5,480	3,920	8.37 (27.5)	
	lb		*30,620	20,550	*20,300	13,850	*14,040	10,140	*12,080	8,640		
Ground Line	kg		*13,390	9,060	*10,030	6,070	*6,700	4,490	*5,840	4,010	8.17 (26.8)	
	lb		*29,520	19,970	*22,110	13,380	*14,770	9,900	*12,870	8,840		
-1.5 m (-4.9 ft)	kg	*9,980	*9,980	*11,870	9,050	*9,140	6,020	*6,690	4,490	*6,330	4,380	7.66 (25.1)
	lb	*22,000	*22,000	*26,170	19,950	*20,150	13,270	*14,750	9,900	*13,960	9,660	
-3.0 m (-9.8 ft)	kg			*9,270	9,210	*7,080	6,120		*5,470	5,240	6.79 (22.3)	
	lb			*20,440	20,300	*15,610	13,490		*12,060	11,550		

Boom 5.90 m (19' 4") / Arm 3.05 m (10' 0") / CWT 6,100 kg / Shoe 600 mm (24") triple grouser

Lift-point height m (ft)	Lift-point radius										At max. Reach		
	3.0 m (9.8 ft)		4.5 m (14.8 ft)		6.0 m (19.7 ft)		7.5 m (24.6 ft)		9.0 m (29.5 ft)		Capacity	Reach	
9.0m (29.5 ft)	kg		*6,390	*6,390							*4,740	*4,740	5.15 (16.9)
	lb		*14,090	*14,090							*10,450	*10,450	
7.5 m (24.6 ft)	kg				*6,150	*6,150					*4,010	*4,010	6.8 (22.3)
	lb				*13,560	*13,560					*8,840	*8,840	
6.0 m (19.7 ft)	kg		*6,850	*6,850	*6,330	*6,330	*5,240	5,050			*3,730	*3,730	7.83 (25.7)
	lb		*15,100	*15,100	*13,960	*13,960	*11,550	11,130			*8,220	*8,220	
4.5 m (14.8 ft)	kg	*11,820	*11,820	*9,100	*9,100	*6,770	*5,400	4,950			*3,650	*3,650	8.47 (27.8)
	lb	*26,060	*26,060	*20,060	*20,060	*14,930	*11,900	10,910			*8,050	*8,050	
3.0 m (9.8 ft)	kg		*11,750	10,200	*7,590	6,680	*5,690	4,770			*3,710	3,680	8.81 (28.9)
	lb		*25,900	22,490	*16,730	14,730	*12,540	10,520			*8,180	8,110	
1.5 m (4.9 ft)	kg		*13,610	9,430	*8,690	6,300	*6,080	4,580			*3,910	3,560	8.87 (29.1)
	lb		*30,000	20,790	*19,160	13,890	*13,400	10,100			*8,620	7,850	
Ground Line	kg		*13,640	9,040	*9,770	6,040	*6,470	4,440			*4,290	3,620	8.68 (28.5)
	lb		*30,070	19,930	*21,540	13,320	*14,260	9,790			*9,460	7,980	
-1.5 m (-4.9 ft)	kg	*10,000	*10,000	*12,540	8,930	*9,470	5,940	*6,710	4,390		*4,970	3,900	8.21 (26.9)
	lb	*22,050	*22,050	*27,650	19,690	*20,880	13,100	*14,790	9,680		*10,960	8,600	
-3.0 m (-9.8 ft)	kg			*10,380	9,030	*7,920	5,980				*5,460	4,550	7.41 (24.3)
	lb			*22,880	19,910	*17,460	13,180				*12,040	10,030	

- Lifting capacity is based on ISO 10567.
- Lifting capacity of HX Series does not exceed 75% of tipping load with the machine on firm, level ground or 87% of full hydraulic capacity.
- The Lift-point is bucket pivot mounting pin on the arm (without bucket mass).
- (*) indicates load limited by hydraulic capacity.

BUCKET SELECTION GUIDE & DIGGING FORCE

BUCKETS

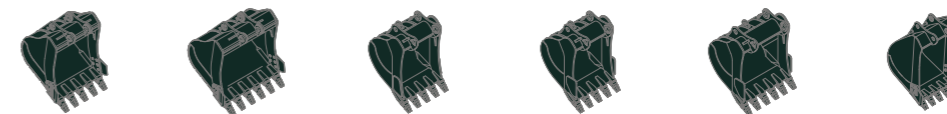

SAE heaped m³ (yd³)	0.80 (1.05)	1.34 (1.75)	◆ 0.90 (1.18)	■ 0.87 (1.14)	■ 1.20 (1.57)	● 0.52 (0.68)
	0.92 (1.20)		◆ 1.05 (1.37)			
	1.10 (1.44)					
	1.20 (1.57)					

Capacity m³ (yd³)	Width mm (in)	Weight kg (lb)	Tooth (EA)	Recommendation mm (ft.in)							
				5,850 (19' 2") Mono Boom			5,900 (19' 4") 2-Piece Boom				
				2,100 (6' 11") Arm	2,500 (8' 2") Arm	3,050 (10' 0") Arm	2,100 (6' 11") Arm	2,500 (8' 2") Arm	3,050 (10' 0") Arm		
◆ 1.08 (1.41)	0.95 (1.24)	1,170 (46.1")	1,020 (2,250)	5	●	●	●	○	●	●	●
◆ 1.27 (1.66)	1.11 (1.45)	1,325 (52.2")	1,100 (2,430)	5	●	●	●	○	●	○	■
◆ 1.50 (1.96)	1.30 (1.70)	1,515 (59.6")	1,180 (2,600)	5	●	●	●	■	○	■	▲
■ 1.27 (1.66)	1.11 (1.45)	1,380 (54.3")	1,290 (2,840)	5	●	○	■	▲	●	○	■
■ 1.46 (1.91)	1.28 (1.67)	1,535 (60.4")	1,380 (3,040)	6	○	○	■	▲	○	■	▲
● 1.16 (1.52)	1.00 (1.31)	1,285 (50.6")	1,380 (3,040)	5	●	●	●	■	●	○	■

- ◆ General Purpose
- Heavy Duty
- Rock-HD
- Applicable for materials with density of 2,100 kgf/m³ (3,500 lbf/yd³) or less
- Applicable for materials with density of 1,800 kgf/m³ (3,000 lbf/yd³) or less
- Applicable for materials with density of 1,500 kgf/m³ (2,500 lbf/yd³) or less
- ▲ Applicable for materials with density of 1,200 kgf/m³ (2,000 lbf/yd³) or less

ATTACHMENT

Booms and arms are welded with a low-stress, full-box section design. 5.85 Mono & 5.90 2-Piece Booms and 2.10 m, 2.50 m, 3.05 m, 3.6 m Arms are available.

BUCKET SELECTION GUIDE & DIGGING FORCE

HX260A L MONO BOOM DIGGING FORCE							
Boom	Length	mm (ft.in)	5,850 (19' 2")				Remark
	Weight	kg (lb)	2,460 (5,420)				
Arm	Length	mm (ft.in)	2,100 (6' 11")	2,500 (8' 2")	3,050 (10' 0")	3,600 (11' 10")	
	Weight	kg (lb)	1,420 (3,130)	1,450 (3,200)	1,540 (3,400)	1,600 (3,530)	
Bucket Digging Force	SAE	kN	153.1 [166.1]	153.6 [167.2]	154.0 [167.2]	154.1 [167.2]	[]: Power Boost
		kgf	15,600 [16,940]	15,700 [17,050]	15,700 [17,050]	15,700 [17,050]	
		lbf	34,403 [37,350]	34,522 [37,590]	34,603 [37,590]	34,638 [37,590]	
	ISO	kN	177.2 [192.7]	177.8 [192.7]	178.2 [193.8]	178.4 [193.8]	
		kgf	18,100 [19,650]	18,100 [19,650]	18,200 [19,760]	18,200 [19,760]	
		lbf	39,819 [43,320]	39,957 [43,320]	40,051 [43,560]	40,092 [43,560]	
Arm Crowd Force	SAE	kN	159.2 [172.5]	134.3 [145.8]	113.3 [122.5]	103.1 [111.8]	[]: Power Boost
		kgf	16,200 [17,590]	13,700 [14,870]	11,500 [12,490]	10,500 [11,400]	
		lbf	35,777 [38,780]	30,188 [32,780]	25,461 [27,540]	23,170 [25,130]	
	ISO	kN	167.7 [182.1]	140.8 [153.3]	118.2 [127.8]	107.0 [116.0]	
		kgf	17,100 [18,570]	14,400 [15,630]	12,000 [13,030]	10,900 [11,830]	
		lbf	37,698 [40,940]	31,651 [34,460]	26,553 [28,730]	24,056 [26,080]	

Note : Boom weight includes arm cylinder, piping, and pin. Arm weight includes bucket cylinder, linkage, and pin

HX260A L 2-PIECE BOOM DIGGING FORCE							
Boom	Length	mm (ft.in)	5,900 (19' 4")				Remark
	Weight	kg (lb)	3,000 (6,610)				
Arm	Length	mm (ft.in)	2,100 (6' 11")	2,500 (8' 2")	3,050 (10' 0")		
	Weight	kg (lb)	1,420 (3,130)	1,450 (3,200)	1,540 (3,400)		
Bucket Digging Force	SAE	kN	153.1 [166.1]	153.6 [167.2]	154.0 [167.2]	154.0 [167.2]	[]: Power Boost
		kgf	15,600 [16,940]	15,700 [17,050]	15,700 [17,050]	15,700 [17,050]	
		lbf	34,403 [37,350]	34,522 [37,590]	34,603 [37,590]	34,603 [37,590]	
	ISO	kN	177.2 [192.7]	177.8 [192.7]	178.2 [193.8]	178.2 [193.8]	
		kgf	18,100 [19,650]	18,100 [19,650]	18,200 [19,760]	18,200 [19,760]	
		lbf	39,819 [43,320]	39,957 [43,320]	40,051 [43,560]	40,051 [43,560]	
Arm Crowd Force	SAE	kN	159.2 [172.5]	134.3 [145.8]	113.3 [122.5]	113.3 [122.5]	[]: Power Boost
		kgf	16,200 [17,590]	13,700 [14,870]	11,500 [12,490]	11,500 [12,490]	
		lbf	35,777 [38,780]	30,188 [32,780]	25,461 [27,540]	25,461 [27,540]	
	ISO	kN	167.7 [182.1]	140.8 [153.3]	118.2 [127.8]	118.2 [127.8]	
		kgf	17,100 [18,570]	14,400 [15,630]	12,000 [13,030]	12,000 [13,030]	
		lbf	37,698 [40,940]	31,651 [34,460]	26,553 [28,730]	26,553 [28,730]	

Note : Boom weight includes arm cylinder, piping, and pin. Arm weight includes bucket cylinder, linkage, and pin

STANDARD/OPTIONAL EQUIPMENT

ENGINE	STD
Cummins B6.7	•
HYDRAULIC SYSTEM	STD
Electric Pump Flow Control (EPFC)	
3-Power Mode, 2-Work Mode, User Mode	•
Variable Power Control	•
Pump Flow Control	•
Attachment Mode Flow Control	•
Engine Auto Idle	•
Electronic Swing Parking Brake	•
Engine Auto Shutdown Control	•
Electronic Fan Control	•
Hyundai Bio Hydraulic oil (HBHO)	•
CABIN & INTERIOR	STD
ISO Standard cabin	
Rise-Up Type Windshield Wiper	•
Radio / USB Player	•
Handsfree Mobile Phone System with USB	•
12V Power Outlet (24V DC to 12V DC converter)	•
Electric Horn	•
All-Weather Steel Cab with 360° Visibility	•
Safety Glass - Tempered Glass	•
Safety Glass - Laminated Glass, Front Window & Glass	•
Sliding Fold-In Front Window	•
Sliding Side Window (LH)	•
Lockable Door	•
Hot & Cool Box	•
Storage Compartment	•
Ashtray & Cigar Lighter	•
Transparent Cabin Roof-Cover	•
Sun Visor	•
Door And Cab Locks, One Key	•
Pilot-Operated Slidable Joystick	•
Console Box Height Adjust System	•
Automatic climate control	
Air Conditioner & Heater	•
Defroster	•
Starting Aid (Air Grid Heater) for Cold Weather	•
Centralized monitoring	
8" LCD Display	•
Engine Speed or Trip Meter / Accel.	•
Engine Coolant Temperature Gauge	•
Max Power	•
Low Speed / High Speed	•
Auto Idle	•
Overload	•
Check Engine	•
Air Cleaner Clogging	•
Indicators	•
ECO Gauges	•
Fuel Level Gauge	•
Hyd. Oil Temperature Gauge	•
Fuel Warmer	•
Warnings	•
Communication Error	•
Low Battery	•
Clock	•
Cabin Lights	•
Cabin Front Window Rain Guard	•
Cabin Roof-Steel Cover	•
Seat	
Adjustable Air Suspension Seat With Heater	•
Mechanical Suspension Seat With Heater	•
Cabin FOG (ISO 10262) Level 2	
FOG (Falling Object Protective Structure) - ISO 10262 Level 2	•
Cabin ROPS	
ROPS (Roll Over Protective Structures) - ISO 1211 7-2	•

SAFETY	STD
Battery Master Switch	•
Rearview Camera	•
AAVM (Advanced Around View Monitoring)	•
Four Front Working Lights (2 Boom Mounted, 2 Front Frame Mounted)	•
Travel Alarm	•
Rear Work Lamp	•
Beacon Lamp	•
Automatic Swing Brake	•
Boom Holding System	•
Arm Holding System	•
Safety Lock Valve For Boom Cylinder With Overload Warning Device	•
Safety Lock Valve For Arm Cylinder	•
Swing Lock System	•
Three Outside Rearview Mirrors	•
Front Guard - Wire Net	•

OTHER	STD
Booms	
5.85 m, 19' 2" Mono	•
5.90 m, 19' 4" 2-Piece	•
Arms	
2.10 m, 6' 11"	•
2.50 m, 8' 2"	•
3.05 m, 10' 0"	•
3.60 m, 11' 10"	•
Removable Clean-Out Dust Net For Cooler	•
Removable Reservoir Tank	•
Fuel Warmer	•
Self-Diagnostics System	•
Hi-MATE (Remote Management System)	•
Batteries (2 x 12 V x 100 AH)	•
Fuel Filler Pump (50 l/min)	•
Single-Acting Piping Kit (Breaker, Etc.)	•
Double-Acting Piping Kit (Clamshell, Etc.)	•
2 way Proportional RCV & Pedal control selection	•
Rotating Piping Kit	•
Quick Coupler Piping	•
Quick Coupler Engcon Tiltrotator	•
One Pedal Straight Travel System	•
Accumulator For Lowering Work Equipment	•
Pattern Change Valve (2 Patterns)	•
Fine Swing Control System	•
Tool Kit	•

UNDERCARRIAGE	STD
Lower Frame Under Cover (Additional)	•
Lower Frame Under Cover (Normal)	•
Track Shoes	•
Triple Grousers Shoes (600 mm, 1' 12")	•
Triple Grousers Shoes (700 mm, 2' 4")	•
Triple Grousers Shoes (800 mm, 2' 7")	•
Triple Grousers Shoes (900 mm, 2' 11")	•
Track Rail Guard	•

* Standard and optional equipment may vary. Contact your Hyundai dealer for more information. The machine may vary according to International standards.

* The photos may include attachments and optional equipment that are not available in your area.

* Materials and specifications are subject to change without advance notice.

* All imperial measurements rounded off to the nearest pound or inch.



Specifications and design are subject to change without notice. Pictures of Hyundai Construction Equipment Europe products may show other than standard equipment.

Hyundai Construction Equipment Europe nv.
Hyundailaan 4, 3980 Tessenderlo, Belgium.
Tel: (+32) 14-56-2200 Fax: (+32) 14-59-3405

EN-2020-07 Rev 0

Ready to experience the Hyundai Effect?

Contact your Hyundai dealer.
hyundai-ce.eu/en/dealer-locator