

**Robex** Equipped with EU Stage IIIB Engine

**55-9A**  
**60CR-9A**

**80CR-9A**

MOVING YOU FURTHER

**HYUNDAI HEAVY INDUSTRIES**



 **HYUNDAI**

# PRIDE AT WORK

Hyundai Heavy Industries strives to build state-of-the-art earthmoving equipment to give every operator maximum performance, optimal controllability, versatile machine settings and proven technology.

***Be proud of your work with Hyundai!***



\*Photo may include optional equipment.

---

## Machine Walk-Around

---

### Engine Technology

The fuel efficient, Tier 4 final certified Yanmar 4TNV98 engine provides proven, reliable power. This engine is electronically controlled for optimum fuel to air ratio and clean, efficient combustion and provides low noise, anti-restart features.

### Efficient Control System

All control devices are arranged for higher productivity and improved operator comfort. Efficient and ergonomic controls allow an operator to control the machine in any working environment.

A safety lever on the left-side console is provided to prevent exiting the cabin while hydraulic controls are live.

### Advanced Hydraulic System

The advanced hydraulic system includes an arm flow summation system, boom holding system and a swing parking brake for smooth and fine control. Other valuable features include a hydraulic damper in the travel pedal, and a hydraulically lubricated swing reducer with a leak-free grease chamber.

### Comfortable and Durable Cabin

The cabin is roomy and ergonomically designed, for reduced noise and good visibility. The cabin frame meets international standard TOPS, ROPS, FOPS ensuring operator safety.

### Operator Convenience

Convenient operator features include a suspension seat, excellent visibility, and variable storage space for advanced operator comfort. The newly designed LED cluster provides current information, including engine RPM, engine coolant, fuel level, and electric components.

A hydraulic function safety lock and auto diagnostic features are also available. lock and failure diagnosis functions are also integrated.

A powerful air conditioning system and Radio & USB player contribute to a productive work environment.

### Easy and Simple Maintenance

Wide open access of doors, covers, hoods is designed for easier maintenance.

The air cleaner and centralized grease fittings are also integrated for easy service.

### Extended Life of Components

Long life components and wear parts, including hydraulic filters, oil, shims and bushings, help to reduce operating costs.



# PREFERENCE

An operator, who sets his machine to his needs, takes pleasure in his work. Operators can fully customize their work environment and operating preferences to fit their individual needs.



\*Photo may include optional equipment.



## Spacious Cabin with Excellent Visibility

The newly designed cabin was conceived for more space, a wider field of view and operator comfort. Special attention was given to a clear, open and convenient interior with plenty of visibility on the machine surroundings and the job at hand. This well balanced combination of precision aspects put the operator in the perfect position to work safely and securely.

## Operator Comfort

In the cabin of the 9A series you can experience the highest level of comfort. The ergonomic location of joysticks with arm rests, suspension seat, control levers and LED-display minimizes fatigue of the operator. The LED-display shows all information of the machine with a blink of an eye.

1. A large top glass combined with a roll-up sun visor offers high visibility.
2. An advanced audio system with radio / MP3-player with USB-input, combined with a remote control is installed to listen to your preferred music favorites.
3. Operators are able to call while operating with the hands-free mobile phone feature.
4. Ergonomically designed joysticks reduce operator fatigue.
5. Cabin provides various storage compartments for operator's convenience.



Roll-up Sun visor    Radio / MP3-player with remote control    Hands-free cell phone    Ergonomic joysticks    Storage compartments

## Stressless

Work is stressful enough; your working environment should be stressless. Hyundai's 9A compact excavator provides many convenient devices for safe and productive work.

1. The window locking device keeps the right window in the preferred position.
2. The sliding front window is easy to open and can be locked safely in open position to improve ventilation and visibility.
3. The tiltable console box offers easy access to the cabin.
4. The powerful temperature control provides the operator with the preferred air temperature.



Window locking device

Sliding front window

Tilttable console box

Climate control system



## Easy-to-use Cluster

The advanced LED-cluster allows the operator to select his personal machine preferences. The monitor displays engine rpm, engine temperature and state of electronic devices. The operator can select auto deceleration mode and max power mode and he can control travel speed with the touch of a button. An engine starting lock prevents theft of the machine.

# PERFORMANCE

9A Series deliver fast precision by combining smoother hydraulics with wider view and less stress. Innovative hydraulic system technologies make the excavator fast, smooth and easy to control.



\*Photo may include optional equipment.

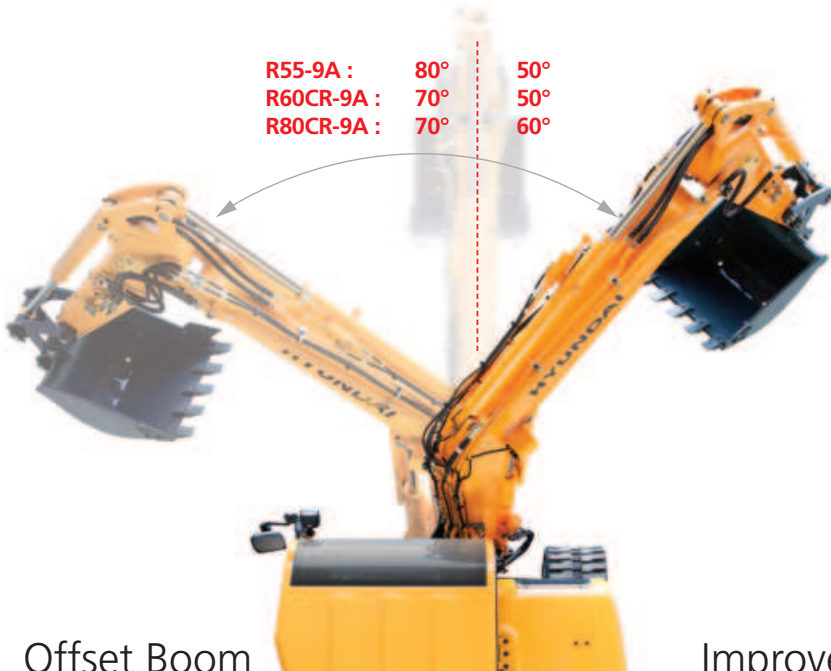

## Offset Boom

The 9A Series boom offset function is designed for efficient work in congested residential and urban areas. Increased swing torque provides better operating capability on a slope.

## Improved Hydraulic System

To achieve optimum precision, Hyundai redesigned the hydraulic system to provide the operator with super fine touch and high controllability. Improved pump flow control reduces hydraulic flow when controls are not activated to minimize fuel consumption. Improved hydraulic valves, precise variable volume piston pumps and fine-touch pilot controls make any operator of our 9A series look like a smooth operator.

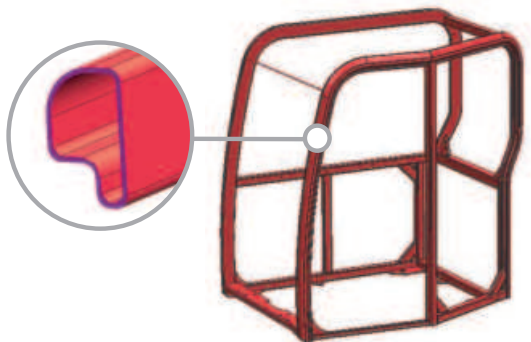

## Structural Strength

The 9A Series cabin structure is designed with slimmer but stronger tubing for more safety and better visibility. Low-stress and high strength steel is welded to form a strong and stable lower frame. Structural durability is analyzed and tested by FEM-analysis (Finite Elements Method) and long-term durability tests.



## High Performance on Narrow Jobsites

The 9A Series reduced tail swing radius allows the operator to work with less worries on narrow jobsites such as road building or urban areas. The Compact radius design provides efficient operation with limited space.

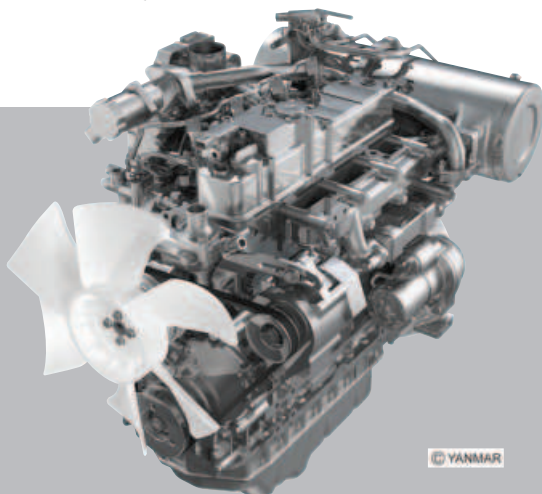

## Yanmar 4TNV98

Yanmar 4TNV98 engine provides a nominal power

R55-9A : 66.9 HP (49.9 kW) / 2,400 rpm

R60CR-9A : 64.7 HP (48.3 kW) / 2,200 rpm

R80CR-9A : 66.9 HP (49.9 kW) / 2,400 rpm

This means the 9A Series runs with the most power in its class, giving you more power to get the job done.

# PROFITABILITY

9A series machines are designed to maximize profitability through improved fuel efficiency, enhanced service features and long-lasting components.



\*Photo may include optional equipment.



## Fuel Efficient

9A series compact excavators are engineered to be very fuel efficient.



## Easy Maintenance

Centralized grease fittings and easy to change air filter provide faster and easier maintenance.

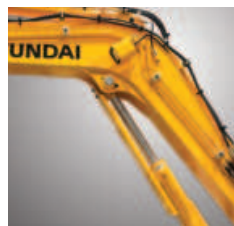

## Improved Durability

A cover of the dozer cylinder provides extra protection in tough working conditions.

## Large Engine hood

9A series compact excavator are offering easy access to the engine compartment with a large engine hood.

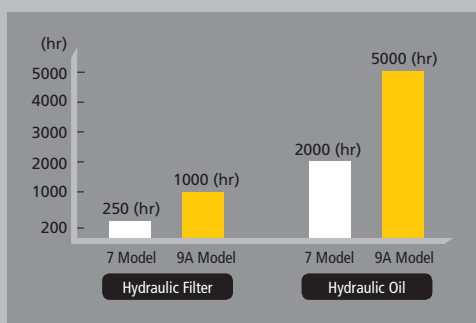

## Extended Life of Components

By adopting long-life hydraulic filters (1000 hrs) and long-life hydraulic oil (5000 hrs) operation costs are reduced.

Extended lubricant bush life & ultra high molecular weight polymer shim, more efficient cooling systems and integrated preheating systems are extending service intervals and reducing machine down time.

# SPECIFICATIONS

Robex 55-9A

## ENGINE

MODEL		YANMAR 4TNV98C	
Type		Water cooled, 4 cycle Diesel, 4-Cylinders in line, direct injection and low emission	
Rated flywheel horse power	SAE	J1995 (gross)	66.9 HP (49.9 kW) / 2,400 rpm
		J1349 (net)	65.1 HP (48.5 kW) / 2,400 rpm
	DIN	6271/1 (gross)	66.9 PS (49.9 kW) / 2,400 rpm
		6271/1 (net)	65.1 PS (48.5 kW) / 2,400 rpm
Max. torque		24 kgf.m (174 lbf.ft) / 1,560 rpm	
Bore x stroke		98 mm (3.86") x 110 mm (4.33")	
Piston displacement		3,319 cc (203 cu in)	
Batteries		1 x 12V x 100 Ah	
Starting motor		12V - 3.0 kW	
Alternator		12V - 80 A	

## HYDRAULIC SYSTEM

MAIN PUMP	
Type	Two variable displacement axial piston pumps
Max. flow	2 x 62.5 l/min pumps
Sub-pump for pilot circuit	Gear pump

Cross-sensing and fuel saving pump system

HYDRAULIC MOTORS	
Travel	Two speed axial piston motor with counter balance valve and parking brake
Swing	Axial piston motor with automatic brake

RELIEF VALVE SETTING	
Implement circuits	220 kgf/cm <sup>2</sup> (3,130 psi)
Travel	220 kgf/cm <sup>2</sup> (3,130 psi)
Swing circuit	220 kgf/cm <sup>2</sup> (3,130 psi)
Pilot circuit	30 kgf/cm <sup>2</sup> (430 psi)
Service valve	Installed

HYDRAULIC CYLINDERS	
No. of cylinder-bore x stroke	Boom: 1-110 x 715 mm (4.3" x 28.1")
	Arm: 1-90 x 850 mm (3.5" x 33.5")
	Bucket: 1-80 x 660 mm (3.1" x 26.0")
	Boom swing: 1-95 x 535 mm (3.7" x 21.1")
	Dozer blade: 1-110 x 219 mm (4.3" x 8.6")

## DRIVES & BRAKES

Drive method	Fully hydrostatic type
Drive motor	Axial piston motor, in-shoe design
Reduction system	Planetary reduction gear
Max. drawbar pull	5,300 kgf (11,700 lbf)
Max. travel speed (high) / (low)	4.1 km/hr (2.5 mph) / 2.1 km/hr (1.3 mph)
Gradeability	35° (70 %)
Parking brake	Multi wet disc

## CONTROL

Pilot pressure operated joysticks and pedals with detachable lever provide almost effortless and fatigueless operation.

Pilot control	Two joysticks with one safety lever (LH): Swing and arm (RH): Boom and bucket (ISO)
Traveling and steering	Two levers with pedals
Engine throttle	Electric, Dial type

## SWING SYSTEM

Swing motor	Fixed displacement axial pistons motor
Swing reduction	Planetary gear reduction
Swing bearing lubrication	Grease-bathed
Swing brake	Multi wet disc
Swing speed	9.1 rpm

## COOLANT & LUBRICANT CAPACITY

	liter	US gal	UK gal
Refilling			
Fuel tank	120.0	31.7	26.4
Engine coolant	9.5	2.5	2.1
Engine oil	11.6	3.1	2.6
Swing device	1.5	0.4	0.3
Final drive (each)	1.2	0.3	0.3
Hydraulic system	120.0	31.7	26.4
Hydraulic tank	70.0	18.5	15.4

## UNDERCARRIAGE

The X-leg type center frame is integrally welded with reinforced box-section track frames. The undercarriage includes lubricated rollers, idlers, track adjusters with shock absorbing springs and sprockets, and a track chain with double or triple grouser shoes.

Center frame	X - leg type
Track frame	Pentagonal box type
No. of shoes on each side	40
No. of upper roller on each side	1
No. of lower roller on each side	5

## OPERATING WEIGHT (APPROXIMATE)

Operating weight, including 3,000 mm (9' 10") boom, 1,600 mm (5' 3") arm, SAE heaped 0.18 m<sup>3</sup> (0.24 yd<sup>3</sup>) bucket, lubricant, coolant, full fuel tank, full hydraulic tank and all standard equipments.

MAJOR COMPONENT WEIGHT	
Upperstructure	2,710 kg (5,970 lb)
Mono boom (with arm cylinder)	310 kg (680 lb)

OPERATING WEIGHT	
Operating weight	5,650 kg (12,460 lb)

• Mono boom with blade

**BUCKETS R55-9A**

Capacity m <sup>3</sup> (yd <sup>3</sup> )		Width mm (in)		Weight kg (lb)
SAE heaped	CECE heaped	Without side cutters	With side cutters	
0.07 m <sup>3</sup> (0.09 yd <sup>3</sup> )	0.06 m <sup>3</sup> (0.08 yd <sup>3</sup> )	315 mm (12.4")	360 mm (14.2")	115 kg (255 lb)
0.18 m <sup>3</sup> (0.24 yd <sup>3</sup> )	0.15 m <sup>3</sup> (0.20 yd <sup>3</sup> )	670 mm (26.4")	740 mm (29.1")	170 kg (375 lb)

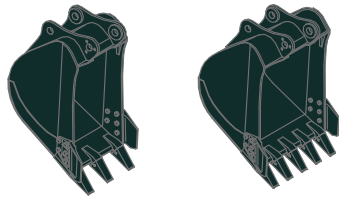

SAE heaped m<sup>3</sup>(yd<sup>3</sup>)      0.07 m<sup>3</sup> (0.09 yd<sup>3</sup>)      0.18 m<sup>3</sup> (0.24 yd<sup>3</sup>)

**DIGGING FORCE R55-9A**

Arm	Length	1,600 mm (5' 3")	1,900 mm (6' 3")
	Weight	210 kg (460 lb)	230 kg (510 lb)
Bucket digging force	SAE	37.7 kN	37.7 kN
		3,850 kgf	3,850 kgf
	ISO	8,490 lbf	8,490 lbf
		42.4 kN	42.4 kN
Arm crowd force	SAE	4,330 kgf	4,330 kgf
		9,550 lbf	9,550 lbf
		28.4 kN	25.5 kN
	ISO	2,900 kgf	2,600 kgf
		6,390 lbf	5,730 lbf
		31.9 kN	28.7 kN
		3,260 kgf	2,930 kgf
		7,190 lbf	6,460 lbf

Arm weight includes cylinder and linkage.

**Lifting Capacities**

**R55-9A**

Rating over-front Rating over-side or 360 degrees

Boom : 3.0 m (9' 10") / Arm : 1.6 m (5' 3") / Bucket : 0.18 m<sup>3</sup> (0.24 yd<sup>3</sup>) SAE heaped / Dozer blade down











Load point height m (ft)		Load radius								At max. reach		
		2.0 m (7 ft)		3.0 m (10 ft)		4.0 m (13 ft)		5.0 m (16 ft)		Capacity		Reach m (ft)
5.0 m (16 ft)	kg									*950	*950	4.12 (13.5)
4.0 m (13 ft)	kg					*1020	*1020			*2090	*2090	5.08 (16.7)
3.0 m (10 ft)	kg					*1090	*1090			*1010	650	5.60 (18.4)
2.0 m (7 ft)	kg	*3050	*3050	*1690	*1690	*1320	1100	*1170	760	*2230	1430	5.84 (19.2)
1.0 m (3 ft)	kg	*6720	*6720	*3730	*3730	*2910	2430	*2580	1680	*2310	1300	5.85 (19.2)
Ground Line	kg	*2350	*2350	*2700	1540	*1790	1000	*1350	720	*1140	610	5.63 (18.5)
-1.0 m (-3 ft)	kg	*5180	*5180	*5950	3400	*3950	2200	*2980	1590	*2510	1340	5.13 (16.8)
-2.0 m (-7 ft)	kg	*3600	3020	*2670	1530	*1800	990			*1180	700	4.23 (13.9)
-3.0 m (-10 ft)	kg	*7940	6660	*5890	3370	*3970	2180			*2600	1540	
	kg	*3770	3060	*2300	1540					*1140	960	
	kg	*8310	6750	*5070	3400					*2510	2120	
	kg	*2040	*2040									
	kg	*4500	*4500									

- Lifting capacity is based on SAE J1097, ISO 10567.
- Lifting capacity of the Robex Series does not exceed 75% of the tipping load with the machine on firm, level ground or 87% of full hydraulic capacity.
- The load point is a hook located on the back of the bucket.
- (\* indicates the load limited by hydraulic capacity.











## R55-9A

 Rating over-front  Rating over-side or 360 degrees











Boom: 3.0 m (9' 10") / Arm: 1.6 m (5' 3") / Bucket: 0.18 m<sup>3</sup> (0.24 yd<sup>3</sup>) SAE heaped / Dozer blade up

Load point height m (ft)		Load radius								At max. reach		
		2.0 m (7 ft)		3.0 m (10 ft)		4.0 m (13 ft)		5.0 m (16 ft)		Capacity		Reach m (ft)
												
5.0 m (16 ft)	kg									*950	*950	4.12
	lb									*2090	*2090	(13.5)
4.0 m (13 ft)	kg					*1020	*1020			*980	740	5.08
	lb					*2250	*2250			*2160	1630	(16.7)
3.0 m (10 ft)	kg					*1090	1080			890	610	5.60
	lb					*2400	2380			1960	1340	(18.4)
2.0 m (7 ft)	kg	*3050	*3050	*1690	1630	*1320	1030	1040	710	810	550	5.84
	lb	*6720	*6720	*3730	3590	*2910	2270	2290	1570	1790	1210	(19.2)
1.0 m (3 ft)	kg			2250	1510	1430	980	1010	690	800	540	5.85
	lb			4960	3330	3150	2160	2230	1520	1760	1190	(19.2)
Ground Line	kg	*2350	*2350	2170	1440	1390	940	990	670	840	570	5.63
	lb	*5180	*5180	4780	3170	3060	2070	2180	1480	1850	1260	(18.5)
-1.0 m (-3 ft)	kg	*3600	2780	2150	1420	1370	930			970	660	5.13
	lb	*7940	6130	4740	3130	3020	2050			2140	1460	(16.8)
-2.0 m (-7 ft)	kg	*3770	2830	2170	1440					*1140	900	4.23
	lb	*8310	6240	4780	3170					*2510	1980	(13.9)
-3.0 m (-10 ft)	kg	*2040	*2040									
	lb	*4500	*4500									

Boom: 3.0 m (9' 10") / Arm: 1.9 m (6' 3") / Bucket: 0.18 m<sup>3</sup> (0.24 yd<sup>3</sup>) SAE heaped / Dozer blade down

Load point height m (ft)		Load radius								At max. reach		
		2.0 m (7 ft)		3.0 m (10 ft)		4.0 m (13 ft)		5.0 m (16 ft)		Capacity		Reach m (ft)
												
5.0 m (16 ft)	kg									*870	*870	4.58
	lb									*1920	*1920	(15.0)
4.0 m (13 ft)	kg									*900	700	5.43
	lb									*1980	1540	(17.8)
3.0 m (10 ft)	kg					*950	*950	*990	780	*930	590	5.91
	lb					*2090	*2090	*2180	1720	*2050	1300	(19.4)
2.0 m (7 ft)	kg			*1440	*1440	*1190	1110	*1080	760	*970	540	6.13
	lb			*3170	*3170	*2620	2450	*2380	1680	*2140	1190	(20.1)
1.0 m (3 ft)	kg	*2050	*2050	*2160	1630	*1500	1050	*1220	740	*1020	530	6.14
	lb	*4520	*4520	*4760	3590	*3310	2310	*2690	1630	*2250	1170	(20.1)
Ground Line	kg	*2280	*2280	*2610	1540	*1730	1000	*1320	710	*1060	550	5.93
	lb	*5030	*5030	*5750	3400	*3810	2200	*2910	1570	*2340	1210	(19.5)
-1.0 m (-3 ft)	kg	*3230	2980	*2700	1510	*1810	980	*1310	700	*1100	620	5.48
	lb	*7120	6570	*5950	3330	*3990	2160	*2890	1540	*2430	1370	(18.0)
-2.0 m (-7 ft)	kg	*4140	3020	*2450	1520	*1630	980			*1100	810	4.67
	lb	*9130	6660	*5400	3350	*3590	2160			*2430	1790	(15.3)
-3.0 m (-10 ft)	kg	*2760	*2760	*1640	1570							
	lb	*6080	*6080	*3620	3460							

Boom: 3.0 m (9' 10") / Arm: 1.9 m (6' 3") / Bucket: 0.18 m<sup>3</sup> (0.24 yd<sup>3</sup>) SAE heaped / Dozer blade up

Load point height m (ft)		Load radius								At max. reach		
		2.0 m (7 ft)		3.0 m (10 ft)		4.0 m (13 ft)		5.0 m (16 ft)		Capacity		Reach m (ft)
												
5.0 m (16 ft)	kg									*870	*870	4.58
	lb									*1920	*1920	(15.0)
4.0 m (13 ft)	kg									*900	660	5.43
	lb									*1980	1460	(17.8)
3.0 m (10 ft)	kg					*950	*950	*990	740	810	550	5.91
	lb					*2090	*2090	*2180	1630	1790	1210	(19.4)
2.0 m (7 ft)	kg			*1440	*1440	*1190	1040	1040	720	750	500	6.13
	lb			*3170	*3170	*2620	2290	2290	1590	1650	1100	(20.1)
1.0 m (3 ft)	kg	*2050	*2050	*2160	1530	1440	980	1010	690	740	490	6.14
	lb	*4520	*4520	*4760	3370	3170	2160	2230	1520	1630	1080	(20.1)
Ground Line	kg	*2280	*2280	2170	1440	1390	940	990	670	770	510	5.93
	lb	*5030	*5030	4780	3170	3060	2070	2180	1480	1700	1120	(19.5)
-1.0 m (-3 ft)	kg	*3230	2740	2140	1410	1360	910	980	660	870	580	5.48
	lb	*7120	6040	4720	3110	3000	2010	2160	1490	1920	1280	(18.0)
-2.0 m (-7 ft)	kg	*4140	2780	2150	1420	1370	920			*1100	760	4.67
	lb	*9130	6130	4740	3130	3020	2030			*2430	1680	(15.3)
-3.0 m (-10 ft)	kg	*2760	*2760	*1640	1470							
	lb	*6080	*6080	*3620	3240							

- Lifting capacity is based on SAE J1097, ISO 10567.
- Lifting capacity of the Robex Series does not exceed 75% of the tipping load with the machine on firm, level ground or 87% of full hydraulic capacity.
- The load point is a hook located on the back of the bucket.
- (\*) indicates the load limited by hydraulic capacity.

**DIMENSIONS R55-9A**

mm (ft. in)

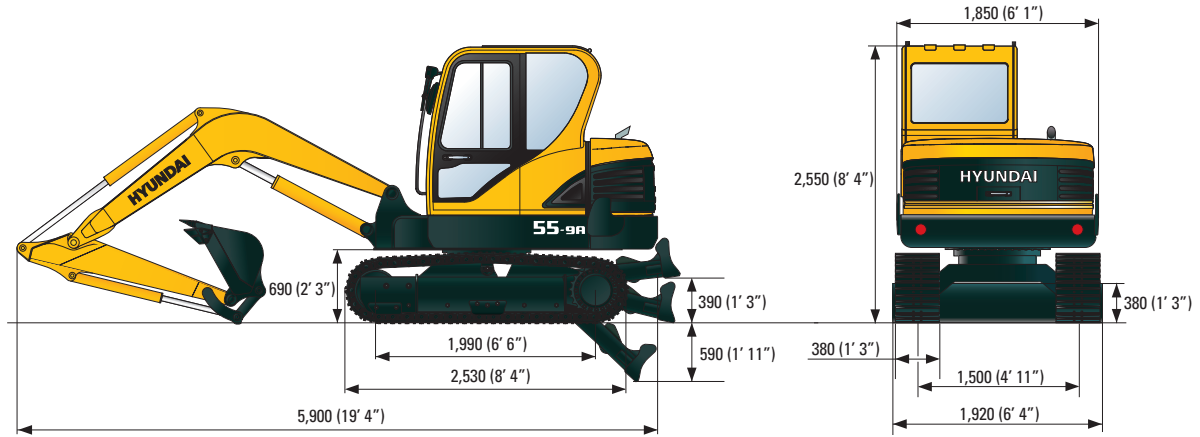

**WORKING RANGE R55-9A**

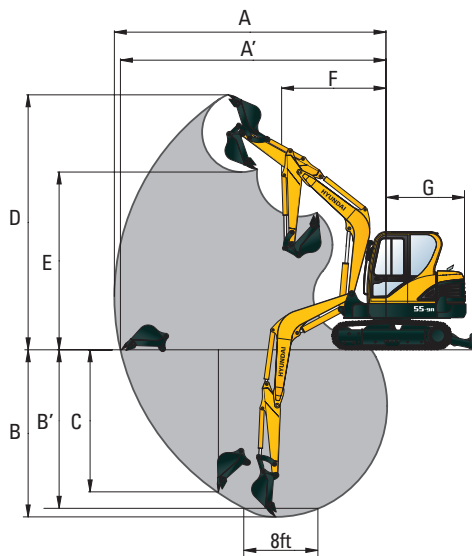

mm (ft. in)

Boom length	3,000 (9' 10")	
Arm length	1,600 (5' 3")	1,900 (6' 3")
A Max. digging reach	6,150 (20' 2")	6,400 (20' 1")
A' Max. digging reach on ground	6,010 (19' 9")	6,270 (20' 7")
B Max. digging depth	3,820 (12' 6")	4,060 (13' 4")
B' Max. digging depth (8' level)	3,420 (11' 3")	3,700 (12' 2")
C Max. vertical wall digging depth	3,200 (10' 6")	3,460 (11' 4")
D Max. digging height	5,780 (18' 12")	5,920 (19' 5")
E Max. dumping height	4,050 (13' 3")	4,180 (13' 9")
F Min. front swing radius	2,350 (7' 9")	2,360 (7' 9")
G Tail swing radius	1,650 (5' 5")	1,650 (5' 5")

## STANDARD EQUIPMENT R55-9A

ISO standard cabin
Cabin ROPS (ISO 3471)
FOPS (ISO 3449)
FOG (ISO 10262 Level I)
TOPS (ISO 12117)
All-weather steel cab with all-around visibility
Safety glass windows
Rise-up type windshield wiper
Sliding fold-in front window
Sliding side window
Lockable door
Storage compartment & Ashtray
Centralized monitoring
Engine speed
Gauges
- Fuel level gauge
- Engine coolant temperature gauge
Warning lamps
- Fuel level
- Engine oil pressure
- Engine coolant temperature
- Hyd. oil temperature
- Low battery
- Air cleaner clogging
Door and locks, one key fits all
Radio / USB Player with remote control
Two outside rearview mirrors
Fully adjustable suspension seat with seat belt
Console box tilting system (LH.)
Front working lights
Electric horn
Battery (1 x 12 V x 100 Ah)
Battery master switch
12 volt power supply
Removable clean-out screen for coolers
Automatic swing brake
Water separator, fuel line
Mono boom (3.0 m; 9' 10")
Arm (1.6 m; 5' 3")
Track rail guard
Starting Aid (air grid heater) for cold weather
Safety lock valve for boom cylinder with overload warning device
Safety lock valve for arm cylinder
Air conditioner & heater
Fuel filler pump (35 l/min)
Double acting piping (clamshell, etc)
Accumulator, work equipment lowering
Travel alarm
Rubber crawler (400 mm; 16")

## OPTIONAL EQUIPMENT R55-9A

Beacon lamp
Single acting piping (Breaker, etc)
Quick coupler
Long arm (1.9 m; 6'3")
Tool kit
Steel track shoes (380 mm; 15")
Front working lights cabin
Road liners
Heavy counterweight



# SPECIFICATIONS

Robex 60CR-9A

## ENGINE

MODEL	YANMAR 4TNV98C		
Type	Water cooled, 4 cycle Diesel, 4-Cylinders in line, direct injection and low emission		
Rated flywheel horse power	SAE	J1995 (gross)	64.7 HP (48.3 kW) at 2,200 rpm
		J1349 (net)	63 HP (47.0 kW) at 2,200 rpm
	DIN	6271/1 (gross)	65.6 PS (48.3 kW) at 2,200 rpm
		6271/1 (net)	63.9 PS (47.0 kW) at 2,200 rpm
Max. torque	24 kgf.m (174 lbf.ft) at 1,560 rpm		
Bore x stroke	98 mm (3.86") x 110 mm (4.33")		
Piston displacement	3,319 cc (203 cu in)		
Batteries	1 x 12 V x 100 Ah		
Starting motor	12 V - 3.0 kW		
Alternator	12 V - 60 A		

## HYDRAULIC SYSTEM

MAIN PUMP	
Type	Two variable displacement axial piston pumps
Max. flow	2 x 55 l/min (14.5 US gpm / 12.5 UK gpm) pumps
Sub-pump for pilot circuit	Gear pump

Cross-sensing and fuel saving pump system

### HYDRAULIC MOTORS

Travel	Two speed axial piston motor with counter balance valve and parking brake
Swing	Axial piston motor with automatic brake

### RELIEF VALVE SETTING

Implement circuits	220 kgf/cm <sup>2</sup> (3,130 psi)
Travel	220 kgf/cm <sup>2</sup> (3,130 psi)
Swing circuit	220 kgf/cm <sup>2</sup> (3,130 psi)
Pilot circuit	30 kgf/cm <sup>2</sup> (430 psi)
Service valve	Installed

### HYDRAULIC CYLINDERS

No. of cylinder-bore x stroke	Boom: 1-110 x 715 mm (4.3" x 28.1")
	Arm: 1-85 x 840 mm (3.3" x 33.1")
	Bucket: 1-80 x 660 mm (3.1" x 26.0")
	Boom swing: 1-95 x 519 mm (3.7" x 20.4")
	Dozer blade: 1-110 x 224 mm (4.3" x 8.8")

## OPERATOR'S CAB

Noise Levels (dynamic value)	
Outside cabin - LwA	97 dB
Inside cabin - LpA	76 dB

## DRIVES & BRAKES

Drive method	Fully hydrostatic type
Drive motor	Axial piston motor, in-shoe design
Reduction system	Planetary reduction gear
Max. drawbar pull	5,300 kgf (11,700 lbf)
Max. travel speed (high) / (low)	4.0 km/hr (2.5 mph) / 2.2 km/hr (1.4 mph)
Gradeability	35° (70%)
Parking brake	Multi wet disc

## CONTROL

Pilot pressure operated joysticks and pedals with detachable lever provide almost effortless and fatiguelless operation.

Pilot control	Two joysticks with one safety lever (LH): Swing and arm (RH): Boom and bucket (ISO)
Traveling and steering	Two levers with pedals
Engine throttle	Electric, Dial type

## SWING SYSTEM

Swing motor	Fixed displacement axial pistons motor
Swing reduction	Planetary gear reduction
Swing bearing lubrication	Grease-bathed
Swing brake	Multi wet disc
Swing speed	8.8 rpm

## COOLANT & LUBRICANT CAPACITY

	liter	US gal	UK gal
Fuel tank	82.0	21.7	27.5
Engine coolant	11.0	2.9	2.4
Engine oil	11.6	3.1	2.6
Final drive (each)	1.2	0.3	0.3
Hydraulic system	110.0	29.1	24.2
Hydraulic tank	60.0	15.9	13.2

## UNDERCARRIAGE

The X-leg type center frame is integrally welded with reinforced box-section track frames. The undercarriage includes lubricated rollers, idlers, track adjusters with shock absorbing springs and sprockets, and a track chain with double or triple grouser shoes.

Center frame	X - leg type
Track frame	Pentagonal box type
No. of shoes on each side	40
No. of upper roller on each side	1
No. of lower roller on each side	5

## OPERATING WEIGHT (APPROXIMATE)

Operating weight, including 2,900 mm (9'6") boom, 1,480 mm (4'10") arm, SAE heaped 0.18 m<sup>3</sup> (0.24 yd<sup>3</sup>) bucket, lubricant, coolant, full fuel tank, full hydraulic tank and all standard equipments.

MAJOR COMPONENT WEIGHT	
Upperstructure	2,900 kg ( 6,390 lb)
Mono boom (with arm cylinder)	310 kg ( 680 lb)

OPERATING WEIGHT		
Operating weight	Steel track (380 mm)	5,900 kg ( 13,010 lb)
	Rubber track	5,800 kg ( 12,790 lb)
	Steel track (450 mm)	5,960 kg ( 13,140 lb)
Ground pressure	Steel track (380 mm)	0.36 kgf / cm <sup>2</sup> (5.12 psi)
	Rubber track	0.34 kgf / cm <sup>2</sup> (4.83 psi)
	Steel track (450 mm)	0.31 kgf / cm <sup>2</sup> (4.41 psi)



**BUCKETS R60CR-9A**

Capacity m <sup>3</sup> (yd <sup>3</sup> )		Width mm (in)		Weight kg (lb)
SAE heaped	CECE heaped	Without side cutters	With side cutters	
0.07 (0.09)	0.06 (0.08)	315 (12.4")	360 (14.2")	115 (255)
0.18 (0.24)	0.15 (0.20)	670 (26.4")	740 (29.1")	170 (375)

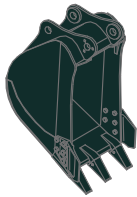

SAE heaped

0.07 m<sup>3</sup> (0.09 yd<sup>3</sup>)

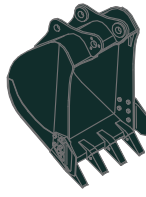

0.18 m<sup>3</sup> (0.24 yd<sup>3</sup>)

**DIGGING FORCE R60CR-9A**

Arm	1.48 m	1.9 m
Bucket digging force	4,170 kgf	4,170 kgf
	40.9 kN	40.9 kN
	9,190 lbf	9,190 lbf
Arm crowd force	2,700 kgf	2,280 kgf
	26.5 kN	22.4 kN
	5,950 lbf	5,030 lbf

**Lifting Capacities**

**R60CR-9A**

Rating over-front Rating over-side or 360 degrees











Boom : 2.9 m (9' 6") / Arm : 1.48 m (4' 10") / Bucket : 0.18 m<sup>3</sup> (0.24 yd<sup>3</sup>) SAE heaped / Dozer blade down

Load point height m (ft)		Load radius								At max. reach		
		2.0 m (7 ft)		3.0 m (10 ft)		4.0 m (13 ft)		5.0 m (16 ft)		Capacity		Reach m (ft)
4.0 m (13 ft)	kg					*1120	*1120			*1050	790	4.99
	lb					*2470	*2470			*2310	1740	(16.4)
3.0 m (10 ft)	kg					*1180	1130			*1080	640	5.56
	lb					*2600	2490			*2380	1410	(18.2)
2.0 m (7 ft)	kg		*1890	1710	*1430	1080	*1250	740	*1120	580	5.82	
	lb		*4170	3770	*3150	2380	*2760	1630	*2470	1280	(19.1)	
1.0 m (3 ft)	kg		*2670	1580	*1740	1020	*1360	720	*1160	560	5.84	
	lb		*5890	3480	*3840	2250	*3000	1590	*2560	1230	(19.2)	
Ground Line	kg	*1980	*1980	*3000	1520	*1930	980	*1430	700	*1190	590	5.61
	lb	*4370	*4370	*6610	3350	*4250	2160	*3150	1540	*2620	1300	(18.4)
-1.0 m (-3 ft)	kg	*3230	3030	*2890	1500	*1910	970			*1210	690	5.09
	lb	*7120	6680	*6370	3310	*4210	2140			*2670	1520	(16.7)
-2.0 m (-7 ft)	kg	*3960	3080	*2370	1530					*1110	990	4.12
	lb	*8730	6790	*5220	3370					*2450	2180	(13.5)











- Lifting capacity is based on SAE J1097, ISO 10567.
- Lifting capacity of the Robex Series does not exceed 75% of the tipping load with the machine on firm, level ground or 87% of full hydraulic capacity.
- The load point is a hook located on the back of the bucket.
- (\*) indicates the load limited by hydraulic capacity.

## R60CR-9A











Boom : 2.9 m (9' 6") / Arm : 1.48 m (4' 10") / Bucket : 0.18 m<sup>3</sup> (0.24 yd<sup>3</sup>) SAE heaped / Dozer blade up

Load point height m (ft)		Load radius								At max. reach		
		2.0 m (7 ft)		3.0 m (10 ft)		4.0 m (13 ft)		5.0 m (16 ft)		Capacity		Reach m (ft.)
												
4.0 m	kg					*1120	1070			1040	740	4.99
(13 ft)	lb					*2470	2360			2290	1630	(16.4)
3.0 m	kg					*1180	1060			860	600	5.56
(10 ft)	lb					*2600	2340			1900	1320	(18.2)
2.0 m	kg			*1890	1600	1430	1010	990	690	780	540	5.82
(7 ft)	lb			*4170	3530	3150	2230	2180	1520	1720	1190	(19.1)
1.0 m	kg			2150	1470	1370	960	970	670	770	520	5.84
(3 ft)	lb			4740	3240	3020	2120	2140	1480	1700	1150	(19.2)
Ground Line	kg	*1980	*1980	2080	1410	1330	920	950	650	810	550	5.61
	lb	*4370	*4370	4590	3110	2930	2030	2090	1430	1790	1210	(18.4)
-1.0 m	kg	*3230	2770	2070	1400	1320	900			940	650	5.09
(-3 ft)	lb	*7120	6110	4560	3090	2910	1980			2070	1430	(16.7)
-2.0 m	kg	*3960	2820	2090	1420					*1110	920	4.12
(-7 ft)	lb	*8730	6220	4610	3130					*2450	2030	(13.5)

Boom : 2.9 m (9' 6") / Arm : 1.48 m (4' 10") / Bucket : 0.18 m<sup>3</sup> (0.24 yd<sup>3</sup>) SAE heaped / Dozer blade down

Load point height m (ft)		Load radius								At max. reach		
		2.0 m (7 ft)		3.0 m (10 ft)		4.0 m (13 ft)		5.0 m (16 ft)		Capacity		Reach m (ft.)
												
4.0 m	kg									*900	670	5.45
(13 ft)	lb									*1980	1480	(17.9)
3.0 m	kg					*950	*950	*950	750	*940	550	5.96
(10 ft)	lb					*2090	*2090	*2090	1650	*2070	1210	(19.6)
2.0 m	kg			*1470	*1470	*1220	1070	*1100	730	*980	500	6.19
(7 ft)	lb			*3240	*3240	*2690	2360	*2430	1610	*2160	1100	(20.3)
1.0 m	kg			*2330	1580	*1560	1010	*1250	700	*1020	490	6.21
(3 ft)	lb			*5140	3480	*3440	2230	*2760	1540	*2250	1080	(20.4)
Ground Line	kg	*2000	*2000	*2850	1480	*1820	950	*1360	670	*1070	510	6.00
	lb	*4410	*4410	*6280	3260	*4010	2090	*3000	1480	*2360	1120	(19.7)
-1.0 m	kg	*2840	*2840	*2920	1450	*1900	930	*1360	660	*1110	580	5.54
(-3 ft)	lb	*6260	*6260	*6440	3200	*4190	2050	*3000	1460	*2450	1280	(18.2)
-2.0 m	kg	*3980	2950	*2590	1460	*1690	930			*1100	760	4.70
(-7 ft)	lb	*8770	6500	*5710	3220	*3730	2050			*2430	1680	(15.4)

Boom : 2.9 m (9' 6") / Arm : 1.48 m (4' 10") / Bucket : 0.18 m<sup>3</sup> (0.24 yd<sup>3</sup>) SAE heaped / Dozer blade up

Load point height m (ft)		Load radius								At max. reach		
		2.0 m (7 ft)		3.0 m (10 ft)		4.0 m (13 ft)		5.0 m (16 ft)		Capacity		Reach m (ft.)
												
4.0 m	kg									890	620	5.45
(13 ft)	lb									1960	1370	(17.9)
3.0 m	kg					*950	*950	*950	700	750	510	5.96
(10 ft)	lb					*2090	*2090	*2090	1540	1650	1120	(19.6)
2.0 m	kg			*1470	*1470	*1220	1000	980	680	690	460	6.19
(7 ft)	lb			*3240	*3240	*2690	2200	2160	1500	1520	1010	(20.3)
1.0 m	kg			2150	1470	1360	940	950	650	670	450	6.21
(3 ft)	lb			4740	3240	3000	2070	2090	1430	1480	990	(20.4)
Ground Line	kg	*2000	*2000	2040	1370	1300	880	920	620	700	470	6.00
	lb	*4410	*4410	4500	3020	2870	1940	2030	1370	1540	1040	(19.7)
-1.0 m	kg	*2840	2660	2010	1340	1270	860	910	610	790	530	5.54
(-3 ft)	lb	*6260	5860	4430	2950	2800	1900	2010	1340	1740	1170	(18.2)
-2.0 m	kg	*3980	2700	2020	1350	1280	860			1040	710	4.70
(-7 ft)	lb	*8770	5950	4450	2980	2820	1900			2290	1570	(15.4)

- Lifting capacity is based on SAE J1097, ISO 10567.
- Lifting capacity of the Robex Series does not exceed 75% of the tipping load with the machine on firm, level ground or 87% of full hydraulic capacity.
- The load point is a hook located on the back of the bucket.
- (\*) indicates the load limited by hydraulic capacity.

**DIMENSIONS R60CR-9A**

mm (ft · in)

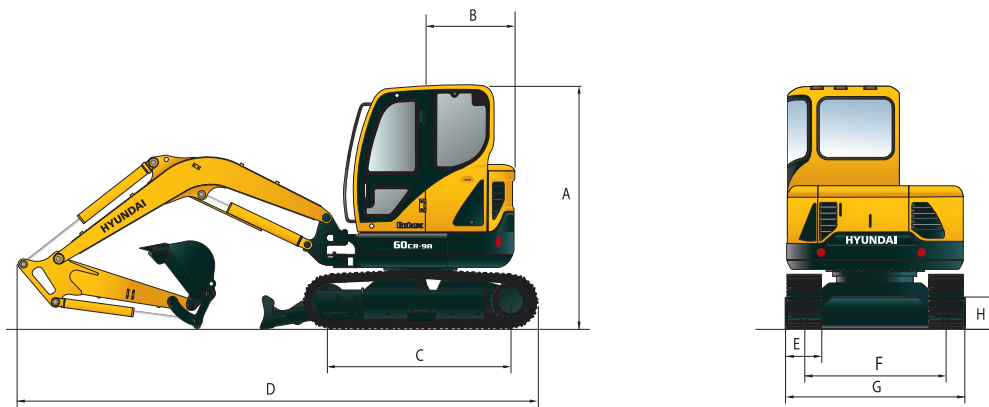

mm (ft · in)

<b>A</b> Overall height of cab	2,550 (8' 4")	<b>E</b> Track shoe width	Steel track	380 (1' 3")
<b>B</b> Tail swing radius	1,080 (3' 7")		Rubber track	400 (1' 4")
<b>C</b> Tumbler distance	1,990 (6' 6")	<b>F</b> Track gauge		1,600 (5' 3")
<b>D</b> Overall length	5,600 (18' 4")	<b>G</b> Overall width		2,000 (6' 7")
		<b>H</b> Ground clearance		380 (1' 3")

**WORKING RANGE R60CR-9A**

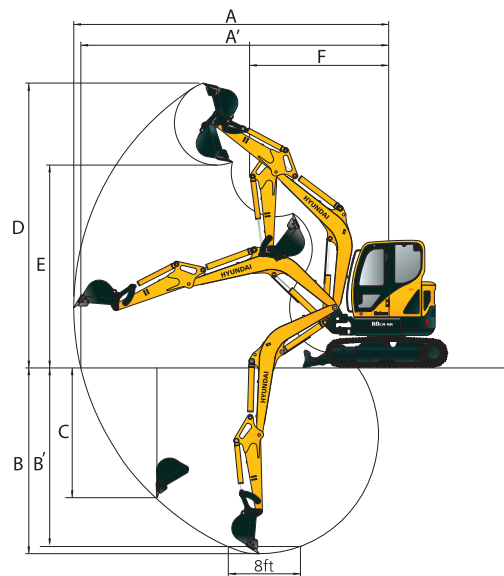

mm (ft · in)

Boom length	2,900 (9' 6")	
Arm length	1,480 (4' 10")	1,900 (6' 3")
<b>A</b> Max. digging reach	6,150 (20' 2")	6,480 (21' 3")
<b>A'</b> Max. digging reach on ground	6,010 (19' 9")	6,350 (20' 10")
<b>B</b> Max. digging depth	3,570 (11' 9")	3,990 (13' 1")
<b>B'</b> Max. digging depth (8' level)	3,160 (10' 5")	3,620 (11' 11")
<b>C</b> Max. vertical wall digging depth	3,040 (9' 12")	3,360 (11' 0")
<b>D</b> Max. digging height	5,680 (18' 8")	5,850 (19' 2")
<b>E</b> Max. dumping height	3,930 (12' 11")	4,100 (13' 5")
<b>F</b> Min. front swing radius	2,420 (7' 11")	2,510 (8' 3")

**STANDARD EQUIPMENT R60CR-9A**

ISO standard cabin
Cabin ROPS (ISO 3471)
FOPS (ISO 3449)
FOG (ISO 10262 Level I)
TOPS (ISO 12117)
All-weather steel cab with all-around visibility
Safety glass windows
Rise-up type windshield wiper
Sliding fold-in front window
Sliding side window
Lockable door
Storage compartment & Ashtray
Centralized monitoring
Engine speed
Gauges
- Fuel level gauge
- Engine coolant temperature gauge
Warning lamps
- Fuel level
- Engine oil pressure
- Engine coolant temperature
- Hyd. oil temperature
- Low battery
- Air cleaner clogging
Fuel pre-filter
Air conditioner & heater
Door and locks, one key fits all
Radio / USB Player with remote control
Outside rearview mirrors
Fully adjustable suspension seat with seat belt
Console box tilting system (LH.)
Two front working lights
Electric horn
Battery (1 x 12 V x 100 Ah)
Battery master switch
12 volt power supply
Automatic swing brake
Removable reservoir tank
Water separator, fuel line
Mono boom (2.9 m; 9' 6")
Arm (1.48 m; 4' 10")
Track rail guard
Starting Aid (air grid heater) for cold weather
Dozer blade
Road liner
Safety lock valve for boom cylinder with overload warning device
Safety lock valve for arm cylinder
Double acting piping (clamshell, etc)
Rubber track (400 mm; 1' 4")

**OPTIONAL EQUIPMENT R60CR-9A**

Fuel filler pump (35ℓ/min, 9.2 US gpm)
Beacon lamp
Single acting piping (Breaker, etc)
Accumulator, work equipment lowering
Electric transducer
Travel alarm
Long arm (1.9 m; 6' 3")
Tool kit
Cabin rear work lamp
Lever pattern change valve
Additional counterweight (200 kg; 440 lb)
Steel track with rubber pads (380 mm)
Quick coupler piping



# SPECIFICATIONS

**Robex 80CR-9A**

## ENGINE

MODEL	YANMAR 4TNV98C		
Type	Water cooled, 4 cycle Diesel, 4-Cylinders in line, direct injection and low emission		
Rated flywheel horse power	SAE	J1995 (gross)	66.9 HP (49.9 kW) at 2,400 rpm
		J1349 (net)	65.1 HP (48.5 kW) at 2,400 rpm
	DIN	6271/1 (gross)	67.8 PS (49.9 kW) at 2,400 rpm
		6271/1 (net)	66 PS (48.5 kW) at 2,400 rpm
Max. torque	24.0 kgf.m (173.6 lbf.ft) at 1,560 rpm		
Bore x stroke	98 mm (3.86") x 110 mm (4.33")		
Piston displacement	3,319 cc (202 cu in)		
Batteries	2 x 12 V x 100 Ah		
Starting motor	12 V - 3.0 kW		
Alternator	12 V - 60 A		

## HYDRAULIC SYSTEM

MAIN PUMP	
Type	Variable displacement piston pumps
Max. flow	2 x 68.4 ℓ/min (18.1 US gpm / 15.0 UK gpm) pumps
Sub-pump for pilot circuit	Gear pump
Cross-sensing and fuel saving pump system	
HYDRAULIC MOTORS	
Travel	Two speed axial piston motor with counter balance valve and parking brake
Swing	Axial piston motor with automatic brake
RELIEF VALVE SETTING	
Implement circuits	P1 / P2 : 280 kgf/cm <sup>2</sup> (3,980 psi) P3 : 230 kgf/cm <sup>2</sup> (3,270 psi)
Travel circuit	300 kgf/cm <sup>2</sup> (4,267 psi)
Swing circuit	250 kgf/cm <sup>2</sup> (3,560 psi)
Pilot circuit	35 kgf/cm <sup>2</sup> (500 psi)
Service valve	Installed

## HYDRAULIC CYLINDERS

No. of cylinder-bore x stroke	Boom: 1-115 x 850 mm (4.5" x 33.5")
	Arm: 1-100 x 870 mm (3.9" x 34.3")
	Bucket: 1-85 x 685 mm (3.3" x 27.0")
	Boom swing: 1-110 x 744 mm (4.3" x 29.3")
	Dozer blade: 1-130 x 152 mm (5.1" x 6.0")

## OPERATOR'S CAB

Noise Levels (dynamic value)	
Outside cabin - LwA	99 dB
Inside cabin - LpA	76 dB

## DRIVES & BRAKES

Drive method	Fully hydrostatic type
Drive motor	Axial piston motor, in-shoe design
Reduction system	Planetary reduction gear
Max. drawbar pull	7,400 kgf (16,310 lbf)
Max. travel speed (high) / (low)	4.6 km/hr (2.9 mph) / 2.8 km/hr (1.7 mph)
Gradeability	35° (70 %)
Parking brake	Multi wet disc

## CONTROLS

Pilot pressure operated joysticks and pedals with detachable lever provide almost effortless and fatigueless operation.

Pilot control	Two joysticks with one safety lever (LH): Swing and arm (RH): Boom and bucket (ISO)
Traveling and steering	Two levers with pedals
Engine throttle	Electric, Dial type

## SWING SYSTEM

Swing motor	Axial piston motor
Swing reduction	Planetary gear reduction
Swing bearing lubrication	Grease-bathed
Swing brake	Multi wet disc
Swing speed	9.1 rpm

## COOLANT & LUBRICANT CAPACITY

	liter	US gal	UK gal
Fuel tank	120.0	31.7	26.4
Engine coolant	11.0	2.9	2.4
Engine oil	11.6	3.1	2.6
Final drive (each)	1.2	0.3	0.3
Hydraulic system	120.0	31.7	26.4
Hydraulic tank	71.0	18.8	15.6

## UNDERCARRIAGE

The X-leg type center frame is integrally welded with reinforced box-section track frames. The undercarriage includes lubricated rollers, idlers, track adjusters with shock absorbing springs and sprockets, and a track chain with double or triple grouser shoes.

Center frame	X - leg type
Track frame	Pentagonal box type
No. of shoes on each side	39
No. of upper roller on each side	1
No. of lower roller on each side	5

## OPERATING WEIGHT (APPROXIMATE)

Operating weight, including 3,400 mm (12' 2") boom, 1,670 mm (5' 6") arm, SAE heaped 0.28 m<sup>3</sup> (0.37 yd<sup>3</sup>) bucket, lubricant, coolant, full fuel tank, full hydraulic tank and all standard equipments.

MAJOR COMPONENT WEIGHT	
Upperstructure	4,090 kg (9,020 lb)
Mono boom (with arm cylinder)	550 kg (1,210 lb)

## OPERATING WEIGHT

Operating weight	Steel track (450 mm)	8,350 kg (18,410 lb)
	Steel track (600 mm)	8,510 kg (18,760 lb)
	Rubber track (450 mm)	8,250 kg (18,190 lb)

- Mono boom with blade

Ground pressure	Steel track (450 mm)	0.39 kgf.m / cm <sup>2</sup> (5.55 psi)
	Steel track (1,600 mm)	0.29 kgf.m / cm <sup>2</sup> (4.12 psi)
	Rubber track (450mm)	0.38 kgf.m / cm <sup>2</sup> (5.40 psi)

**BUCKETS R80CR-9A**

Capacity m <sup>3</sup> (yd <sup>3</sup> )		Width mm (in)		Weight kg (lb)
SAE heaped	CECE heaped	Without side cutters	With side cutters	
0.14 (0.18)	0.13 (0.17)	390 (15.4")	470 (18.5")	185 (410)
0.28 (0.37)	0.25 (0.33)	730 (28.7")	810 (31.9")	230 (510)



SAE heaped

0.14 m<sup>3</sup> (0.18 yd<sup>3</sup>)

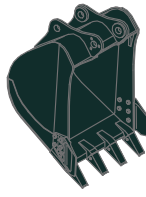

0.28 m<sup>3</sup> (0.37 yd<sup>3</sup>)

**DIGGING FORCE (ISO) R80CR-9A**

Arm	1.67 m	2.2 m
Bucket digging force	5,700 kgf	5,700 kgf
	55.9 kN	55.9 kN
	12,570 lbf	12,570 lbf
Arm crowd force	4,300 kgf	3,540 kgf
	42.2 kN	34.7 kN
	9,480 lbf	7,800 lbf

**Lifting Capacities**

**R80CR-9A**

Rating over-front Rating over-side or 360 degrees









Boom : 3.4 m (12'2") / Arm : 1.67 m (5'6") / Bucket : 0.28 m<sup>3</sup> (0.37 yd<sup>3</sup>) SAE heaped / Dozer blade down

Load point height m (ft)		Load radius						At max. reach		
		1.5 m (5 ft)		3.0 m (10 ft)		4.5 m (15 ft)		Capacity		Reach m (ft)
4.5 m (15 ft)	kg					*1550	1480	*1470	1040	5.74
	lb					*3420	3260	*3240	2290	(17.9)
3.0 m (10 ft)	kg					*1740	1430	*1530	780	6.23
	lb					*3840	3150	*3370	1720	(20.4)
1.5 m (5 ft)	kg			*4050	2510	*2260	1320	*1620	700	6.45
	lb			*8930	5530	*4980	2910	*3570	1540	(21.2)
Ground Line	kg			*4830	2320	*2650	1230	*1710	740	6.20
	lb			*10650	5110	*5840	2710	*3770	1630	(20.3)
-1.5 m (-5 ft)	kg	*4730	*4730	*4410	2320	*2550	1210	*1760	940	5.38
	lb	*10430	*10430	*9720	5110	*5620	2670	*3880	2070	(17.7)
-3.0 m (-10 ft)	kg			*2810	2430					
	lb			*6190	5360					









- Lifting capacity is based on SAE J1097, ISO 10567.
- Lifting capacity of the Robex Series does not exceed 75% of the tipping load with the machine on firm, level ground or 87% of full hydraulic capacity.
- The load point is a hook located on the back of the bucket.
- (\*) indicates the load limited by hydraulic capacity.

## R80CR-9A









Boom : 3.4 m (12' 2") / Arm : 1.67 m (5' 6") / Bucket : 0.28 m<sup>3</sup> (0.37 yd<sup>3</sup>) SAE heaped / Dozer blade up

Load point height m (ft)		Load radius						At max. reach		
		1.5 m (5 ft)		3.0 m (10 ft)		4.5 m (15 ft)		Capacity		Reach
										m (ft)
4.5 m (15 ft)	kg lb					*1550 *3420	1380 3040	1110 2450	970 2140	5.74 (17.9)
3.0 m (10 ft)	kg lb					1540 3400	1340 2950	840 1850	730 1610	6.23 (20.4)
1.5 m (5 ft)	kg lb			2770 6110	2320 5110	1430 3150	1230 2710	760 1680	650 1430	6.45 (21.2)
Ground Line	kg lb			2570 5670	2140 4720	1330 2930	1140 2510	790 1740	680 1500	6.20 (20.3)
-1.5 m (-5 ft)	kg lb	*4730 *10430	*4730 *10430	2570 5670	2140 4720	1310 2890	1120 2470	1010 2230	870 1920	5.38 (17.7)
-3.0 m (-10 ft)	kg lb			2690 5930	2250 4960					

Boom : 3.4 m (12' 2") / Arm : 2.20 m (7' 3") / Bucket : 0.28 m<sup>3</sup> (0.37 yd<sup>3</sup>) SAE heaped / Dozer blade down

Load point height m (ft)		Load radius						At max. reach				
		1.5 m (5 ft)		3.0 m (10 ft)		4.5 m (15 ft)		6.0 m (20 ft)		Capacity	Reach	
											m (ft)	
4.5 m (15 ft)	kg lb					*1180 *2600	*1180 *2600			*1280 *2820	810 1790	6.17 (20.2)
3.0 m (10 ft)	kg lb					*1410 *3110	*1410 *3110	*1400 *3090	820 1810	*1320 *2910	630 1390	6.84 (22.4)
1.5 m (5 ft)	kg lb			*3280 *7230	2580 5690	*1970 *4340	1310 2890	*1570 *3460	780 1720	*1390 *3060	570 1260	7.03 (23.1)
Ground Line	kg lb	*1900 *4190	*1900 *4190	*4600 *10140	2270 5000	*2470 *5450	1190 2620	*1730 *3810	730 1610	*1460 *3220	590 1300	6.80 (22.3)
-1.5 m (-5 ft)	kg lb	*3590 *7910	*3590 *7910	*4590 *10120	2220 4890	*2580 *5690	1140 2510			*1500 *3310	720 1590	6.09 (20.0)
-3.0 m (-10 ft)	kg lb	*5800 *12790	*5800 *12790	*3530 *7780	2290 5050	*1890 *4170	1190 2620			*1360 *3000	1220 2690	4.58 (15.0)

Boom : 3.4 m (12' 2") / Arm : 2.20 m (7' 3") / Bucket : 0.28 m<sup>3</sup> (0.37 yd<sup>3</sup>) SAE heaped / Dozer blade up

Load point height m (ft)		Load radius						At max. reach				
		1.5 m (5 ft)		3.0 m (10 ft)		4.5 m (15 ft)		6.0 m (20 ft)		Capacity	Reach	
											m (ft)	
4.5 m (15 ft)	kg lb					*1180 *2600	*1180 *2600			870 1920	750 1650	6.17 (20.2)
3.0 m (10 ft)	kg lb					*1410 *3110	1350 2980	880 1940	760 1680	680 1500	580 1280	6.84 (22.4)
1.5 m (5 ft)	kg lb			2850 6280	2390 5270	1420 3130	1220 2690	840 1850	720 1590	610 1340	520 1150	7.03 (23.1)
Ground Line	kg lb	*1900 *4190	*1900 *4190	2520 5560	2090 4610	1290 2840	1100 2430	790 1740	670 1480	640 1410	540 1190	6.80 (22.3)
-1.5 m (-5 ft)	kg lb	*3590 *7910	*3590 *7910	2460 5420	2040 4500	1240 2730	1050 2310			780 1720	660 1460	6.09 (20.0)
-3.0 m (-10 ft)	kg lb	*5800 *12790	*5800 *12790	2540 5600	2110 4650	1290 2840	1100 2430			1320 2910	1130 2490	4.58 (15.0)

- Lifting capacity is based on SAE J1097, ISO 10567.
- Lifting capacity of the Robex Series does not exceed 75% of the tipping load with the machine on firm, level ground or 87% of full hydraulic capacity.
- The load point is a hook located on the back of the bucket.
- (\* ) indicates the load limited by hydraulic capacity.



**DIMENSIONS R80CR-9A**

mm (ft · in)

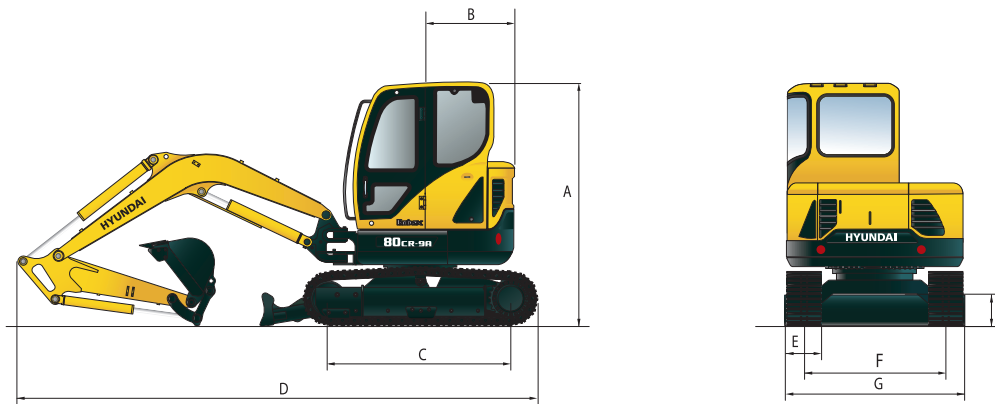

mm (ft · in)

<b>A</b> Overall height of cab	2,640 (8' 7")	<b>E</b> Track shoe width	Steel track	450 (1' 6")
<b>B</b> Tail swing radius	1,280 (4' 2")		Rubber track	450 (1' 6")
<b>C</b> Tumbler distance	2,200 (7' 3")	<b>F</b> Track gauge		1,850 (6' 1")
<b>D</b> Overall length	6,170 (20' 2")	<b>G</b> Overall width		2,300 (7' 7")
		<b>H</b> Ground clearance		360 (1' 2")

**WORKING RANGE R80CR-9A**

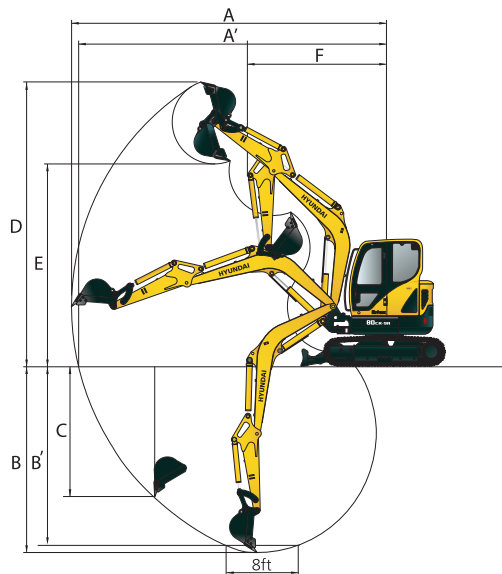

mm (ft · in)

Boom length	3,400 (11' 2")		
Arm length	1,670 (5' 6")		2,200 (7' 3")
<b>A</b> Max. digging reach	6,960 (22' 10")		7,390 (24' 3")
<b>A'</b> Max. digging reach on ground	6,820 (22' 5")		7,250 (23' 9")
<b>B</b> Max. digging depth	4,180 (13' 7")		4,620 (15' 2")
<b>B'</b> Max. digging depth (8' level)	3,780 (12' 5")		4,330 (14' 2")
<b>C</b> Max. vertical wall digging depth	3,570 (11' 9")		4,040 (13' 3")
<b>D</b> Max. digging height	6,750 (22' 1")		7,040 (23' 1")
<b>E</b> Max. dumping height	4,730 (15' 6")		5,050 (16' 7")
<b>F</b> Min. front swing radius	2,500 (8' 2")		2,610 (8' 7")

**STANDARD EQUIPMENT R80CR-9A**

---

ISO standard cabin

Cabin ROPS (ISO 12117-2)  
FOPS (ISO 3449)  
FOG (ISO 10262 Level )

---

All-weather steel cab with all-around visibility

---

Safety glass windows

---

Rise-up type windshield wiper

---

Sliding fold-in front window

---

Sliding side window

---

Lockable door

---

Storage compartment & Ashtray

---

Centralized monitoring

---

Engine speed

---

Gauges

---

- Fuel level gauge

---

- Engine coolant temperature gauge

---

Warning lamps

---

- Fuel level

---

- Engine oil pressure

---

- Engine coolant temperature

---

- Hyd. oil temperature

---

- Low battery

---

- Air cleaner clogging

---

Fuel pre-filter

---

Air conditioner & heater

---

Double acting piping (clamshell, etc) with proportional RCV Lever

---

Door and locks, one key fits all

---

Radio / USB Player with remote control

---

Outside rearview mirrors

---

Fully adjustable suspension seat with seat belt

---

Console box tilting system (LH.)

---

Three front working lights

---

Electric horn

---

Battery (1 x 12 V x 100 Ah)

---

Battery master switch

---

12 volt power supply

---

Automatic swing brake

---

Removable reservoir tank

---

Water separator, fuel line

---

Mono boom (3.4 m; 11'2")

---

Arm (1.67 m; 5'6")

---

Track shoes (450 mm; 1'6")

---

Track rail guard

---

Starting Aid (air grid heater) for cold weather

**OPTIONAL EQUIPMENT R80CR-9A**

---

Fuel filler pump (35ℓ/min, 9.2 US gpm)

---

Beacon lamp

---

Single acting piping kit

---

Safety lock valve for arm cylinder

---

Track pad (450 mm; 1'6")

---

Accumulator, work equipment lowering

---

Electric transducer

---

Travel alarm

---

Quick coupler

---

Rubber track (450 mm; 1'6")

---

Rubber PAD (450 mm; 1'6")

---

Track shoes (600 mm; 1'12")

---

Long arm (2.2 m; 7'3")

---

Tool kit

---

Cabin rear work lamp

---

Lever pattern change valve (2 pattern)

---

Additional counterweight (400 kg; 880 lb)



# Company Organization

Hyundai Heavy Industries (HHI) had its groundbreaking ceremony in March 1972. HHI spreads across 2,300 acres that cover 1,500 acres of its production facilities and 800 acres of amenities (apartment complexes, schools, and recreational centers). Since the successful construction of its first two 260,000 DWT supertankers in 1974, HHI has built and delivered almost every kind of ship to customers the world over. Backed by technology and experience acquired through shipbuilding as well as streamlined modern facilities and a highly skilled work force, HHI has diversified its business activities from shipbuilding into other heavy industrial fields. On this vast compound, HHI operates various business lines: Shipbuilding, Engine & Machinery, Offshore & Engineering, Industrial Plant & Engineering, Electro Electric Systems, Construction Equipment and Green Energy, ISO 9001 & ISO 14001 certified.



Shipbuilding Division



Construction Equipment Division



Offshore & Engineering Division



Engine & Machinery Division



Electro Electric Systems Division



Industrial Plant & Engineering Division



Green Energy Division



\* Standard and optional equipment may vary. Contact your Hyundai dealer for more information. The machine may vary according to International standards.  
 \* The photos may include attachments and optional equipment that are not available in your area.  
 \* Materials and specifications are subject to change without advance notice.  
 \* All imperial measurements rounded off to the nearest pound or inch.  
 \* The air conditioning system on this machine contains the fluorinated greenhouse gas refrigerant HFC-134a (Global Warming Potential = 1430). The system contains 0.95 kg of refrigerant which has a CO<sub>2</sub> equivalent of 1.3585 metric tonne.

**HYUNDAI CONSTRUCTION EQUIPMENT**

PLEASE CONTACT

**Hyundai Construction Equipment Europe nv**

Hyundailaan 4, 3980 Tessenderlo, Belgium **Tel:** (32) 14-56-2200 **Fax:** (32) 14-59-3405 [www.hyundai.eu](http://www.hyundai.eu)

EN - 2019.06 Rev 1